

The Eaton logo, consisting of the word "EATON" in a bold, white, sans-serif font. The letter "A" is stylized with a white triangle pointing upwards, and the letter "O" has a white dot in the center. The logo is set against a dark red background.

EATON

The Cutler-Hammer logo, consisting of the words "Cutler-Hammer" in a bold, white, sans-serif font. The hyphen between the two words is a simple horizontal line. The logo is set against a dark red background.

Cutler-Hammer

Medium Voltage Expulsion Fuses

Product Focus

Indoor and Outdoor
RBA, RDB, DBU, DBA
8.3kV - 145kV

Contents

<u>Description</u>	<u>Page</u>	<u>Description</u>	<u>Page</u>
Introduction	2	DBA Expulsion Fuses	81-94
Catalog Key System.....	3	DBA Introduction	83
Expulsion Fuse Introduction	4	DBA Features	84
Technical Data	5-9	Operation.....	84
Application Data	10-12	Application.....	84
Appendix	13-18	Ratings.....	84
RBA Expulsion Fuses	19-56	DBA Installation	85-87
RBA Introduction	21	DBA Fuse Curves	89-92
RBA Features	22-28	DBA Catalog Numbers and	
Operations and Features.....	22	Information	93-94
Details.....	23	Cross Reference	95-104
Refill Operations.....	23-26	Style Number to Catalog Number	
Interruption and Protection.....	27-28	Cross Reference.....	97-100
RBA Ratings and Selection		Catalog Number to Style Number	
Information	29	Cross Reference.....	101-104
Dimensional Details	30-31		
Testing and Performance	32		
RBA Installation	33		
Refill Replacement.....	34		
RBA Fuse Curves	35-48		
RBA Catalog Numbers and			
Information	49-56		
DBU Expulsion Fuses	57-80		
DBU Introduction	57		
DBU Features	60-64		
Application.....	60		
Details.....	60-63		
Interruption and Protection.....	62-64		
Dimensional Details	65		
Testing and Performance	66		
DBU Installation	67-68		
DBU Fuse Curves	69-77		
DBU Catalog Numbers and			
Information	78-80		

For over 60 years, Cutler-Hammer has been the World Leader in the design and manufacture of medium voltage power fuses. As the only full-line manufacturer of both current limiting and expulsion fuses, Cutler-Hammer meets the needs of every medium voltage application for the protection of voltage systems from 2.4kV through 145kV.

A better understanding of some fuse terminology will help you understand and select the correct fuse. The following is a brief overview of those terms.

Power vs Distribution

The differentiation is intended to indicate the test conditions and where fuses are normally applied on a power system, based on specific requirements for generating sources, substations and distribution lines. Each class has its own unique set of voltage, current and construction requirements (see ANSI C37.42, .44, .46 and .47).

Low vs Medium vs High Voltage

While fuses are defined in the ANSI Stds as either Low or High Voltage, Cutler-Hammer has elected to name their fuses to correspond with the equipment in which they are

installed. Therefore, per ANSI C84, our fuses are named as follows:

Low Voltage	1000V and below
Medium Voltage	Greater than 1000V to 69,000V
High Voltage	Greater than 69,000V

Expulsion vs Current Limiting

Definitions per ANSI C47.40-1993

Expulsion Fuses: An expulsion fuse is a vented fuse in which the expulsion effect of the gases produced by internal arcing, either alone or aided by other mechanisms, results in current interruption.

An expulsion fuse is not current limiting and as a result limits the duration of a fault on the electrical system, not the magnitude.

Current-Limiting Fuse: A current limiting fuse is a fuse that, when its current responsive element is melted by a current within the fuse's specified current limiting range, abruptly introduces a high resistance to reduce current magnitude and duration, resulting in subsequent current interruption.

Feature Comparison (Figure 1)

Fuse Types

There are three fuse types: Backup, General Purpose and Full Range. It is important that the user have an

understanding of these definitions to insure proper application of the fuse. (Figure 2)

Backup Fuse: A fuse capable of interrupting all currents from the maximum rated interrupting current down to the rated minimum interrupting current.

Backup fuses are normally used for protection of motor starters and are always used in a series with another interrupting device capable of interrupting currents below the fuses minimum interrupting current.

General Purpose Fuses: A fuse capable of interrupting all currents from the rated interrupting current down to the current that causes melting of the fusible element in no less than one hour.

General Purpose fuses are typically used to protect feeders and components such as transformers.

Full Range Fuses: A fuse capable of interrupting all currents from the rated interrupting current down to the minimum continuous current that causes melting of the fusible element, with the fuse applied at the maximum ambient temperature specified by the manufacturer.

Figure 1 - General High Voltage Fuse Comparison

Expulsion	Current Limiting
Vented	Sealed
Electro-Mechanical	Static
Interrupts at Current Zero	Limits Fault Current
Generally Higher Voltage and Current Application Capabilities	Generally Higher Interrupting Ratings
Different Time/Current Characteristics	Different Time/Current Characteristics

▲ Figure 2 - Fuse Types Protection Range

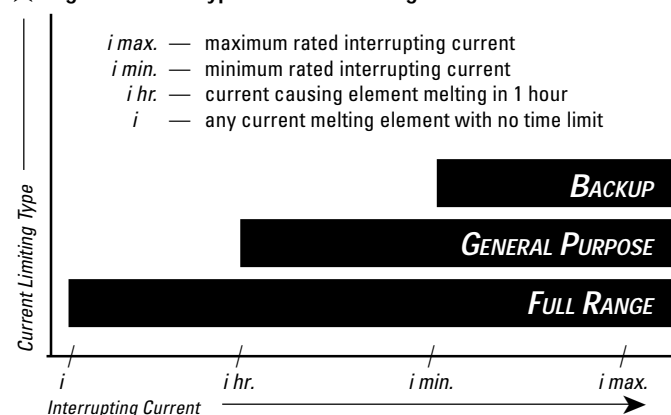

CATALOG NUMBERS

Easy to Use, Easy to Order!

Cutler-Hammer's fuse catalog numbering system makes it easy to order the right fuse. The catalog numbers are easy to remember, unique to each fuse, and are broken down in three descriptive segments: Fuse Type, Voltage Rating and Current Rating.

These Catalog Numbers can be entered directly and easily on VISTALINE.

- No change in order processing will occur if you use either a style number or its corresponding catalog number. You will get the same fuse.
- In the back of this ordering guide is a style number to catalog number cross reference chart.

Examples:

8RBA2-10E	8.3 max. kV, RBA-200 refill, 10E amperes
DBU17-30K	17.1 max. kV, DBU fuse unit, 30 amperes
15RBA8-INH	15.5 max. kV, RBA-800, indicating nondisconnect holder
RBA4-FLTR	RBA-400 filter

Expulsion Fuse Units and Refills

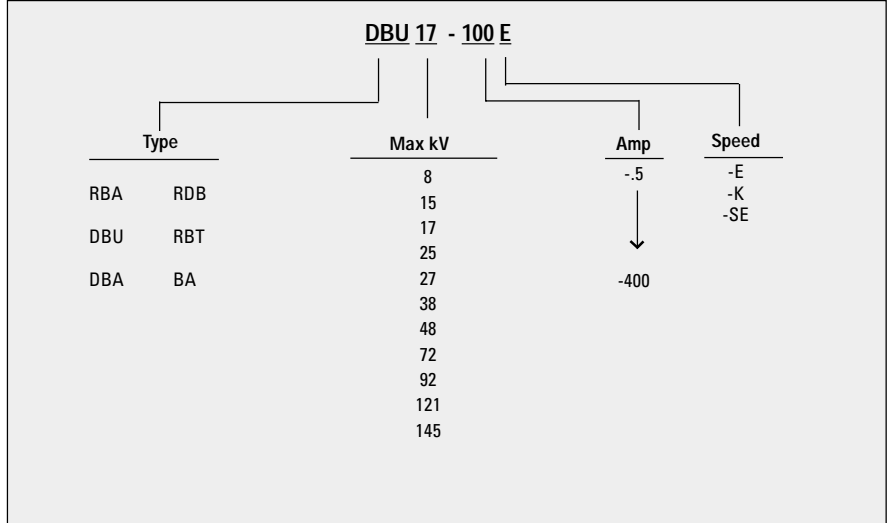

Expulsion Fuse Accessories

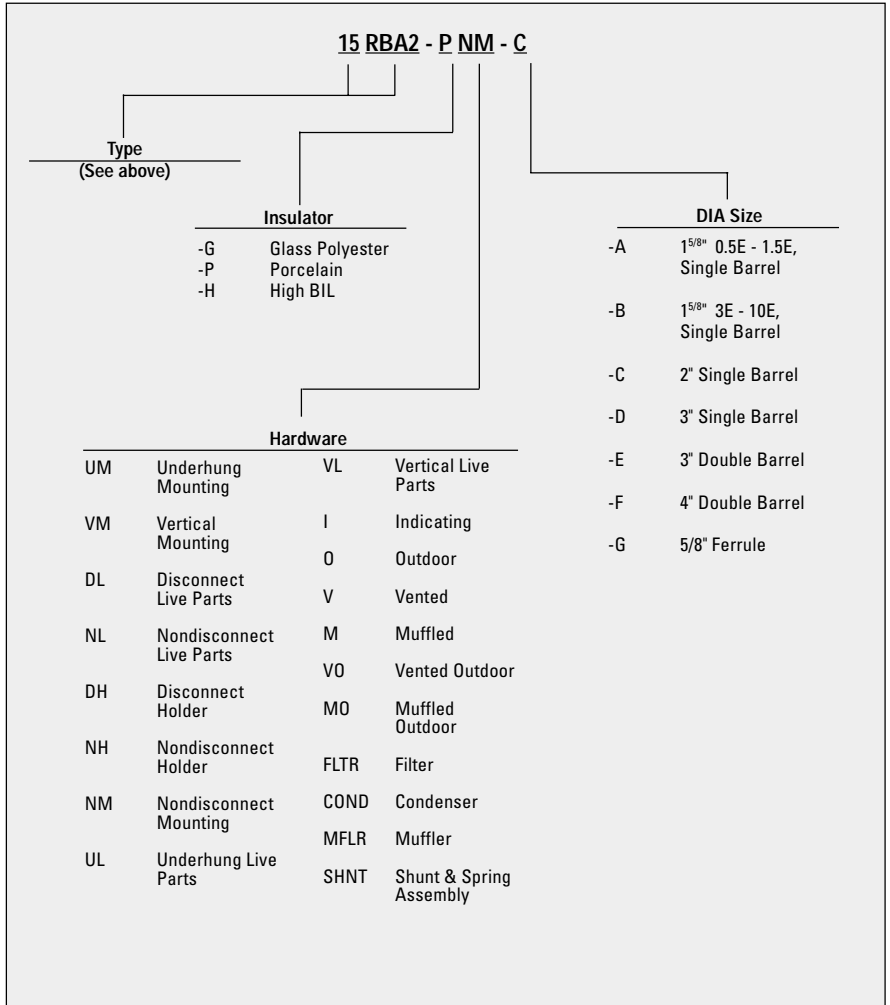

Introduction

Cutler-Hammer power fuses provide diverse characteristics that allow them to be utilized in any application within their practical range. This difference is due to the offering of both expulsion and current limiting power fuses. Expulsion and current limiting fuses employ different interrupting techniques, which cause the criteria with which they are applied to differ. This requires that a different set of questions should be answered when applying Expulsion and Current Limiting fuses. For this reason and to avoid confusion, this application data pertains only to expulsion fuses. For information on the application of current-limiting fuses see the Cutler Hammer Current Limiting Fuse Catalog.

General Information

Expulsion Power Fuses are divided into two types "Refillable" and "Replaceable". Refillable fuses are constructed so that the inner components can be removed and reused when the assembly is

recharged with a new refill. Since they reuse the spring and shunt assembly these components can be constructed with a heavy-duty design which allows the unit to have a higher Interrupting capability. Since the components are reused it is easy to change the fuse size by simply changing the refill. Replaceable fuses have a lower installed cost by providing a more cost-effective construction. This is generally at the expense of higher interrupting ratings.

Cutler-Hammer offers both a indoor and an outdoor refillable style fuse.

The indoor refillable fuse is the "RBA" which stands for Refillable Boric Acid fuse. It is designed to be used indoor with a suppressor which limits the discharge given off by the fuse during operation. Two versions of suppressors are available to limit the discharge. A condenser may be used which fully restricts the discharge but reduces the interrupting rating. A discharge filter is also available which restricts discharge but not to a level which causes a rating reduction. The outdoor refillable fuse is "RDB" fuse which stands for Refillable

Dropout boric acid fuse.

The construction of the RBA and RDB is identical. The main difference in the internal construction is the kickout pin. They both utilize the same refill unit. Externally the RDB outdoor fuse has a tough enamel paint, which provides Ultra Violet protection. The holder has a sealed design to provide a weatherproof ability.

The fuse is comprised of a fuse mounting, fuse holder that includes the spring and shunt assembly, refill and a discharge filter or condenser for indoor applications. These parts are shown in the RBA/RDB section.

Both disconnect and non-disconnect mountings are available for RBA fuses. Each of these mountings has the front connected terminals. Indoor, non-disconnect mountings may be equipped with indicators. Outdoor mountings for the RDB, DBU and DBA, on the other hand, must be disconnecting due to the dropout feature.

Cutler-Hammer offers a replaceable style "DBU" fuse for use in either indoor or outdoor applications. It is a lighter, less expensive fuse than the higher-rated RBA/RDB fuse. The DBA is also offered as a replacement fuse.

For outdoor application of the RDB, DBU and DBA fuses, it is important that unblown fuses are not left hanging in the disconnected position. If the weather seal on these fuses is broken or damaged, it is possible for water to enter and damage the fuse. The integrity of these seals is directly related to the integrity of the fuse. Seals should be checked periodically and replaced, if necessary. The paint on the fuse should also be checked periodically.

Cutler-Hammer expulsion fuses utilize boric acid for the interrupting medium. When a fuse element melts, the heat of the arc

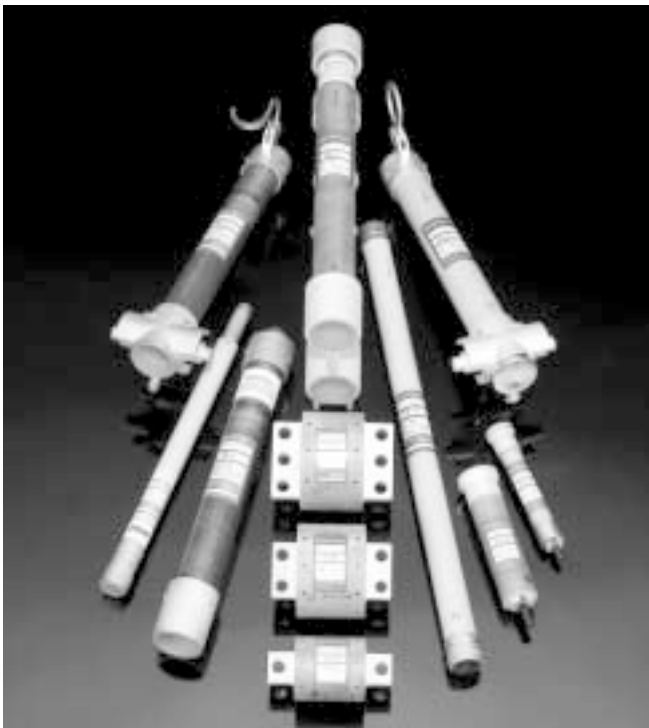

decomposes the boric acid which then produces water vapor and an inert boric anhydride which will extinguish the arc by blasting through it and exiting through the bottom of the fuse. The interruption process produces both an exhaust and a good deal of noise. To moderate exhaust, a discharge filter, muffler or condenser is added to indoor fuses. Discharge filters and mufflers limit the exhaust to a small and relatively inert amount of gas while lowering the noise level, but they have no effect on the fuse's interrupting rating. A condenser almost completely absorbs and contains the exhaust while further lessening the noise level; however, the condenser causes a reduction of the fuse's interrupting rating.

Fuse Selection

There are four factors involved in the selection of a power fuse. The first three considerations are the voltage rating, the interrupting rating including rate of rise of recovery voltage considerations, and the continuous current rating of the fuse. Proper attention should be given to each of these considerations as improper

application in any one area may result in the fuse failing to perform its intended function. The fourth consideration is coordination with line and load side protective equipment that is needed to give selectivity of outage and to prevent premature fuse blowing. Each of the four areas is discussed in detail in the following information.

Voltage Rating

The first consideration regarding fuse application is that the fuse selected must have a maximum design voltage rating equal to or greater than the maximum normal frequency recovery voltage which will be impressed across the fuse by the system under all possible conditions. In most cases this means the maximum design voltage of the fuse must equal or exceed the system maximum line-to-line voltage. The only exception to this rule occurs when fusing single-phase loads connected from line-to-neutral of a four-wire effectively grounded system. Here the fuse maximum design voltage need only exceed the system maximum line-to-neutral voltage

providing it is impossible under all fault conditions for the fuse to experience the full line-to-line voltage.

A good rule of thumb is that if more than one phase of the system is extended beyond the fuse location, the fuse maximum design voltage should equal or exceed the system maximum line-to-line voltage regardless of how the three-phase system is grounded on the source side of the fuse or how the transformers or loads are connected on the load side of the fuse. Many people, however, choose to fuse wye grounded wye transformers with fuses that have a voltage rating which only exceeds the system line-to-neutral voltage. In most cases this presents no problems but the user should be aware of the remote possibility of a secondary phase-to-phase ungrounded fault which could impose full line-to-line voltage across the fuse. When only one phase of a four-wire effectively grounded system is extended beyond the fuse to supply a load connected from phase-to-neutral, it is usually acceptable to have the fuse maximum design voltage equal or exceed the system maximum line-to-neutral voltage.

It is permissible for expulsion fuse voltage ratings to exceed the system voltage by any desired amount but under no circumstances may the system voltage exceed the fuse maximum design voltage.

Interrupting Rating

The rated interrupting capacity of power fuses is the rms value of the symmetrical component (AC component) of the highest current which the fuse is able to successfully interrupt under any condition of asymmetry. In other words, the interrupting rating denotes the maximum symmetrical fault current permitted at the fuse location.

Figure 1: Asymmetry Factor

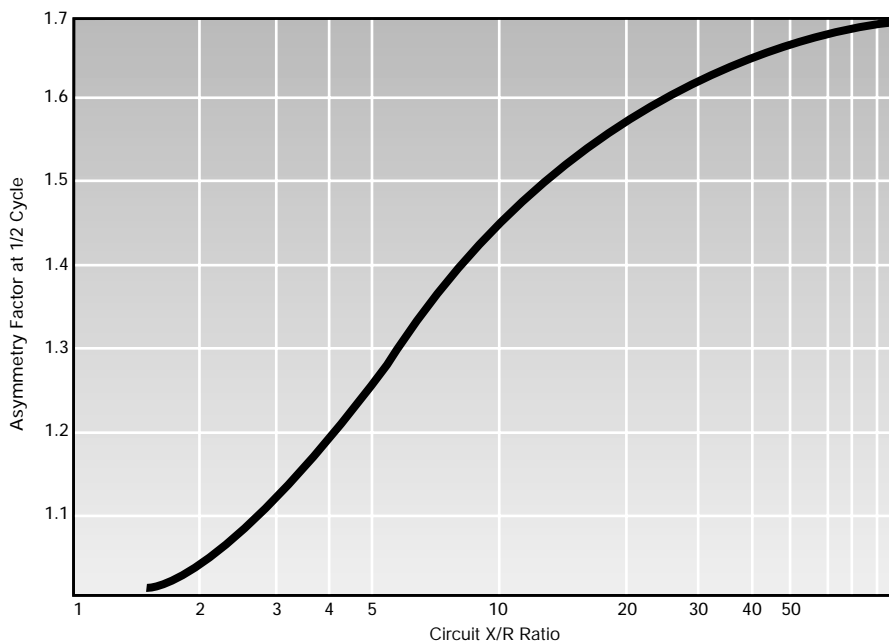

Another way of rating the interrupting rating of power fuses concerns the asymmetrical fault current.

Asymmetrical currents are related to symmetrical currents by the asymmetry factor which is the ratio of the rms value of the asymmetrical current. This includes a DC component, at some instant after fault initiation to the rms value of the symmetrical component of current.

Asymmetry factors for a time corresponding to 1/2 cycle after fault initiation are a function of the circuit X/R ratio and this relationship is shown in Figure (1). Theoretically, the maximum asymmetry factor in a purely inductive circuit is 1.732; however, with the X/R ratios encountered in power circuits it is rarely ever more than 1.6 at 1/2 cycle. Fuse standards, IEEE/ANSI C37.46 Section 2.5, Table 1, suggest an asymmetry factor of 1.56 to 1.6. The minimum asymmetry factor at which Cutler-Hammer power fuses are tested to determine their maximum interrupting rating is 1.6. In general, asymmetrical currents can be converted to their symmetrical counterpart by dividing the asymmetrical value by 1.6.

A third way to rate the interrupting rating of power fuses is with nominal three-phase KVA ratings. Three-phase kVA ratings are calculated by the formula $I \times kV \times 1.732$ where I is the interrupting current in symmetrical rms amperes and kV is the fuse nominal voltage rating. With this method it should be kept in mind that power fuses are not constant kVA devices, that is, if the voltage is half the fuse rating, the interrupting current does not double but remains the same. The fuse will interrupt any current up to the maximum rated interrupting current as long as the normal frequency recovery voltage does not exceed the maximum design voltage rating of the fuse.

Using the KVA rating for anything other than rough overall classification is contrary to the design principles of expulsion power fuses.

Table (1) lists the symmetrical, asymmetrical and nominal three-phase kVA interrupting ratings of Cutler-Hammer expulsion fuse products. Note that use of the condenser reduces the interrupting rating. Values listed in the table are valid for both 50 and 60 hertz systems. For application on 25 hertz systems, the derating factors given in Table (2) should be used to determine the interrupting rating.

When the fusible element in an expulsion fuse melts as the result of a fault, an arc is established inside the fuse. Normal operation of an expulsion fuse causes elongation of the arc. The current will continue to flow in the circuit and within the fuse until a natural current zero is reached. When the arc is extinguished at a current zero, the voltage across the fuse terminals changes from the relatively low arc voltage to the steady state power frequency recovery voltage. This recovery voltage is determined by the system configuration and type of fault and/or load connections. The voltage waveform across the fuse terminals during the transition from arc voltage to power frequency recovery voltage is referred to as the transient recovery voltage. Transient recovery voltages can produce high voltage stresses across the fuse terminals. The dielectric strength between the fuse terminals will rise faster than the transient recovery voltage if a successful interruption is to occur. The impedance in the circuit determines the resonant or natural frequency of the transient recovery voltage after the arc is extinguished. This frequency of oscillation and the amplitude factor are defined as the ratio of the highest peak value of transient recovery voltage to the peak of the power frequency recovery voltage.

This is defined as the transient recovery voltage impressed across the fuse terminals.

Primary faults, or faults on the primary side of a transformer, will generally produce higher short circuit currents and less severe transient recovery voltages. Secondary faults produce lower short circuit currents and more severe transient recovery voltages. This is due to the insertion of the transformer impedance in the circuit. Cutler-Hammer recognizes the effects of different parameters involved in primary and secondary fault phenomenon. The Cutler-Hammer line of fuses have proven their capability to successfully clear against the transient recovery voltages associated with both types of faults. Table (3) lists the natural frequency of the transient recovery voltage and amplitude factors at which these fuses were tested. These fuses meet or exceed the application portion of the ANSI Standards.

Another consideration when applying power fuses is the altitude at which they are installed. The dielectric strength of air decreases with an increase in altitude, necessitating a reduced interrupting rating above 3300 feet. Table (4) gives the correction factors for different altitudes as listed in ANSI C37.40-1993, Section 2.3.

Power fuses have limitations when interrupting low currents. Fuses are fault protective devices, not overload protective devices. No 'E' rated fuse provides protection for all values of overload current between the range of one to two times its continuous current rating. The following section will provide additional details on continuous current.

Under no circumstances should a fuse be applied in a situation where the available fault current exceeds the interrupting rating of the fuse.

Continuous Current Rating

Power fuses are designed so that they can carry their rated current continuously without exceeding the temperature rises permitted by NEMA and ANSI standards. The continuous current ratings available in Cutler-Hammer fuses are shown in Table (5). These current ratings carry an 'E' designation defined in ANSI C37.40-1993 to C37.47-1981.

The current-responsive element of a power fuse rated 100 E amperes or below shall melt in 300 seconds at a rms current within the range of 200 % to 240 % of the continuous current rating.

The current-responsive element with ratings above 100 amperes shall melt in 600 seconds at an rms current within the range of 220% to 264% of the continuous current rating of the fuse unit, refill unit, or fuse link.

Although the 'E' rating does not make time-current curves identical, it does produce a similarity among different manufacturer's fuses, as they all must satisfy the above requirements. The 'E' rating also reflects the 2:1 minimum melting current versus continuous current rating ratio which is a design feature of power fuses resulting from the average requirements of general purpose high voltage fuse applications and inherent features of conventional fuses.

As previously mentioned, power fuses are designed to continuously carry their rated current without exceeding temperature rise restrictions. If the rated current is exceeded by a small amount, an overload situation is encountered. An overload situation is when the fuse is subjected to a current below the 300 or 600 second melting current but substantially above the continuous current rating for an excessive length of time. This type of condition generates a large amount of heat and may cause damage to the fuse. This problem

Table 1: Expulsion Fuse Interrupting Ratings

Voltage kV		Interrupt Ratings					
Nominal	Max. Design	Sym. Amps	Asym. Amps	3-Phase Sym. MVA	Sym. Amps	Asym. Amps	3-Phase Sym. MVA
RBA-RDB-200		RBA-RDB-200 Indoor with Discharge Filter			RBA-200 Indoor with Condenser		
2.40	2.75	19,000	30,000	80	10,000	16,000	42
4.16	4.80	19,000	30,000	137	10,000	16,000	72
4.80	5.50	19,000	30,000	158	10,000	16,000	83
7.20	8.25	16,600	26,500	205	10,000	16,000	125
13.80	14.40	14,400	23,000	345	8,000	12,800	191
14.40	15.50	14,400	23,000	360	8,000	12,800	200
23.00	25.50	10,500	16,800	420	6,300	10,100	250
34.50	38.00	6,900	11,100	410	5,000	8,000	300
RBA-RDB-400		RBA-RDB-400 Indoor with Discharge Filter			RBA-400 Indoor with Condenser		
RBA-RDB-800		RBA-RDB-800 Indoor with Discharge Filter			RBA-800 Indoor with Condenser		
2.4	2.75	37,500	60,000	150	20,000	32,000	84
4.16	4.80	37,500	60,000	270	20,000	32,000	144
4.8	5.50	37,500	60,000	310	20,000	32,000	166
7.2	8.25	29,400	47,000	365	16,000	25,600	200
13.8	14.40	36,000	57,600	859	12,500	20,000	300
14.4	15.50	29,400	47,000	730	12,500	20,000	312
23.0	25.50	21,000	33,500	840	10,000	16,000	400
34.5	38.00	16,800	26,800	1000	10,000	16,000	600
DBU		DBU Outdoor Vented			DBU Indoor with Muffler		
2.4	2.75	14,000	22,400	58	14,000	22,400	58
4.16	4.80	14,000	22,400	100	14,000	22,400	100
4.8	5.50	14,000	22,400	116	14,000	22,400	116
7.2	8.25	14,000	24,000	174	14,000	22,400	174
13.8	14.4	14,000	22,400	334	14,000	22,400	334
14.4	17.1	14,000	22,400	349	14,000	22,400	349
23.0	27.0	12,500	20,000	500	12,500	20,000	500
34.5	38.0	10,000	16,000	600	8,000	12,500	500
DBA-1		DBA-1 Outdoor Vented					
2.4	2.75	6,300	10,100	26
4.16	4.80	6,300	10,100	45
4.8	5.50	6,300	10,100	52
7.2	8.25	6,300	10,100	78
13.8	14.40	6,300	10,100	150
14.4	15.50	6,300	10,100	157
23.0	25.50	6,300	10,100	251
34.5	38.00	5,000	8,000	298
46.0	48.30	4,000	6,400	318
69.0	72.50	2,500	4,000	298
DBA-2		DBA-2 Outdoor Vented					
23.0	25.50	12,500	20,000	497
34.5	38.00	12,500	20,000	746
46.0	48.30	12,500	20,000	995
69.0	72.50	10,000	16,000	1,194

is less severe in the DBU and RBA/RDB standard fuses as they employ silver elements which are, for all practical purposes, undamageable; however, caution should still be exercised when overloading the fuse as the heat generated may produce deterioration of the boric acid interrupting medium and charring of the fuse wall before the fuse element

melts. Figure (2) gives overload characteristics of Cutler Hammer expulsion fuses. Do not exceed these overload restrictions under any circumstances.

In the practical application of expulsion power fuses they are used to protect transformers and other equipment where overloads and inrush currents are common.

As mentioned above, expulsion fuses have a rather low thermal capacity and cannot carry overloads of the same magnitude and duration as motors and transformers of equal continuous currents. For this reason a general fuse application ratio of 1.4:1 fuse continuous current rating to full load current is suggested so the fuse will not blow on acceptable overloads and inrush conditions. Remember that this ratio is a general figure for typical applications and that a ratio as low as 1:1 can be used if the system current will never exceed the rated current of the fuse or a much higher ratio may be needed in other specific applications. More specific application information can be found in the individual equipment application sections that follow.

At times it is desirable to have a continuous current rating larger than any single fuse can provide. Higher ratings may be obtained by paralleling fuses. This practice may be extremely dangerous if the fuses are arbitrarily paralleled as the probability is great that the fuse elements of paralleled expulsion fuses will not melt at the same instant. An occurrence of this nature creates a situation in which the progress of the spring accelerating arcing rod of each of the fuses in parallel will not be uniform. Such a situation could cause a restrike in one of the fuses with the total arcing energy in that fuse exceeding the design level and resulting in a failure to clear the circuit. Under no circumstances should fuses be paralleled unless the paralleling is the extensively tested Cutler Hammer design or the specific application receives engineering approval from the Technical Center.

Corrections for applying expulsion fuses above 3300 feet apply to the continuous current rating as well as the interrupting rating. Refer to Table (4) in this section for correction factors for different altitudes as listed in IEEE/ANSI

Table 2: Derating Factors for 25 Hz

To find the interrupting rating at 25 hertz multiply the desired rating from Table 1 by the appropriate value from the following list.

Voltage kV		Derating Factors		
Nominal	Max. Design	RBA-200 RDB-200 DBU	RDB-400 RBA-800 RDB-800	RBA-400 DBA-1 DBA-2
2.40	2.75	.45	.37	.75
4.16	4.80	.45	.37	.75
4.80	5.50	.45	.37	.75
7.20	8.25	.45	.37	.70
13.80	14.40	.47	.35	.70
14.40	15.50	.47	.35	.70
23.00	25.50	.53	.35	.60
34.50	38.00	.69	.40	.62
46.00	48.3067
69.00	72.5071

Table 3: Transient Recovery Voltage Values for RBA, RDB and DBU Fuses

Voltage kV		Transient Recovery Voltage Values			
Nominal	Max. Design	Primary Fault Recovery Frequency in kHz	Amplitude Factor	Secondary Fault Recovery Frequency in kHz	Amplitude Factor
2.40	2.75	9.0	1.6	26.0	1.6
4.16	4.80	9.0	1.6	26.0	1.6
4.80	5.50	9.0	1.6	26.0	1.6
7.20	8.25	9.0	1.6	26.0	1.6
13.80	14.40	5.5	1.6	17.4	1.6
14.40	15.50	5.5	1.6	17.4	1.6
23.00	25.50	4.2	1.6	13.0	1.6
34.50	38.00	3.9	1.6	8.5	1.6

Table 4: Altitude Corrections from ANSI C37.40-1993, Section 2.3

Altitude (above sea level)		Correction Factor	
Feet	Meters	Interrupting Rating Times	Continuous Current Times
3,300	1,000	1.00	1.00
4,000	1,200	.98	.99
5,000	1,500	.95	.99
6,000	1,800	.92	.98
7,000	2,100	.89	.98
8,000	2,400	.86	.97
9,000	2,700	.83	.96
10,000	3,000	.80	.96
12,000	3,600	.75	.95
14,000	4,300	.70	.93
16,000	4,900	.65	.92
18,000	5,500	.61	.91
20,000	6,100	.56	.90

C37.40-1993, Section 2.3.

Remember that under no circumstances must the continuous rating be less than the continuous load current and that 'E' rated fuses may not provide protection for currents in the range of one or two times the continuous current rating.

Coordination

In addition to selecting a fuse that meets the voltage, interrupting and continuous current ratings, it is important to examine the melting and total clearing time-current characteristics of the fuse. The melting characteristics are expressed as time-current relationships. These relationships are designated as minimum melt

curves and as total clearing curves. The minimum melt curve gives the minimum amount of time in seconds required to melt the fuse elements at a particular value of symmetrical current under specified conditions. Total clearing curves

Figure 2: Overload Characteristics for Cutler-Hammer Expulsion Fuses

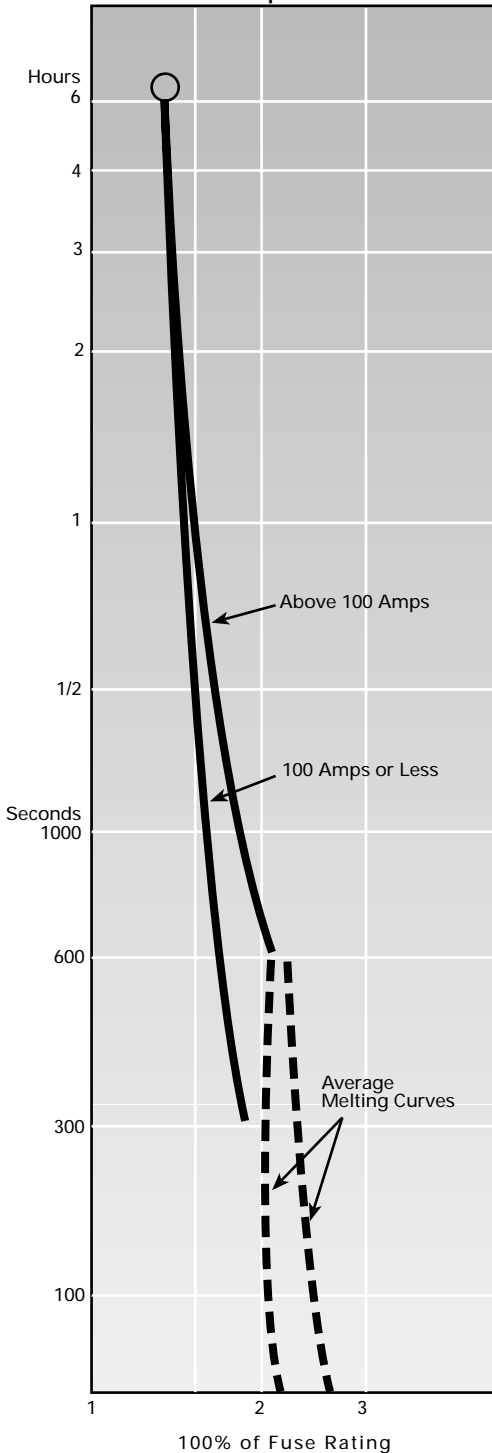

give the maximum amount of time in seconds to complete interruption of the circuit at a particular value of symmetrical current under specified conditions. Arcing time is defined as the amount of time in cycles elapsing from the melting of the fusible element to the final interruption of the circuit. It is important to examine these characteristics to assure proper protection and selectivity with other overcurrent protective devices. These curves are located in each fuse section of this catalog.

The minimum melt curve of all 'E' rated fuses must lie within the range defined in ANSI C37.46-1981 at either the 300 or 600 second point, but there are no limitations placed on the melting time at high currents. To take advantage of this, Cutler Hammer increases the applicability of their fuses by producing a 'fast' or 'standard' fuse and a 'slow' or 'time-lag' fuse. The curves for the 'time-lag' fuse are less inverse and allow for more of a time delay at high currents.

Low currents below the 300 or 600 second melting current are termed overload currents. Overload currents are discussed in the section on continuous current rating where Figure (2) gives the fuse overload characteristics that should not be exceeded under any

circumstances.

Properly coordinating power fuses is basically a problem of keeping the fuse minimum melting curve above the total clearing curve of any downstream overcurrent protective device, and keeping the total clearing curve beneath the minimum melting curve of any upstream protective device. Manufacturer's published time-current curves are based on standard conditions and do not allow for such variables as preloading or ambient temperature. For this reason, it is recommended that a safety zone be used when coordinating power fuses so proper coordination is maintained even when there are shifts in the curves due to changes in the above mentioned variables. There are two approaches used to achieve this safety zone and both produce similar results. One approach employs a 25 percent safety zone in time for a given value of current and the other uses a 10 percent safety zone in current for a given value of time. Cutler Hammer uses the second method as it allows the safety band to be published on the left-hand side of all the time-current curves. Coordination is then achieved by overlaying curves and shifting one by the width of the published safety zone.

Figure 3: Preloading Adjustment Factor for Power Fuses

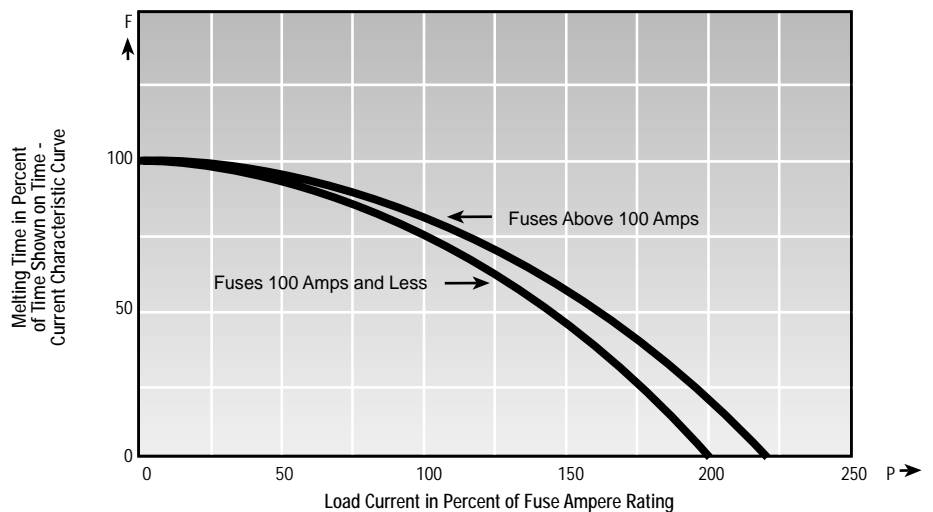

When discussing coordination and time-current curves, it should be pointed out that IEEE/ANSI Standards C37.46-1981, Section 3.1.1 allows the total clearing curves to be drawn at a distance corresponding to 20 percent on the scale to the right of the minimum melting curve. Cutler Hammer uses this 20 percent figure in its published curves but testing has verified that a 10 percent tolerance is more than sufficient for all currents less than that which causes melting in .5 seconds for a given fuse rating.

If desired or if unusual conditions exist, shifts in the time-current curve due to pre-loading may be examined individually. Cutler Hammer time-current characteristics are derived from tests on fuses in an ambient of 25 degrees C and no initial loading as specified in IEEE/ANSI C37.46-1981. Fuses subject to conditions other than the above will experience shifts in the time-current curves. Figure (3) gives the adjusting factor for preloaded fuses. These adjusting factors are valid only for Cutler Hammer power fuses.

Figure (4) gives an example of tightly coordinated fuse application. The figure shows a standard speed RBA fuse protecting the primary of a 1000 KVA transformer with Cutler Hammer type DS low voltage, air circuit breakers protecting the secondary equipment.

Coordination with reclosing circuit breakers may be performed with

the aid of the coordination chart found on page 16, Figure (7). This curve is explained under the Repetitive Fault Section of this catalog section.

Application

When applying expulsion fuses, physical as well as electrical properties must be considered. By their nature, expulsion fuses emit gases from the bottom of the fuse. Care should also be given to maintaining minimum phase-to-phase and phase-to-ground spacing when mounting the fuse. Indoor fuses employ either a discharge filter, muffler or a condenser, but specified clearances must still be maintained. Outdoor fuses are vented and thus have a high noise level and expel a greater amount of gas making clearance from ground an important consideration. When applying outdoor fuses, space must be allowed for the arc the fuse swings through during dropout. Table (6) gives the minimum clearance to ground and the minimum phase spacing.

Outdoor fuses, as mentioned above are vented. The venting of the hot gases resembles a cylindrical column in nature. Height above the minimum ground clearance is not really a factor except as related to rebounding from the ground of hot particles and gases. Figure (5) shows the nature of the discharge and allows the user to suggest specific safety zones for each particular application.

Transformer Application

One of the more common applications of power fuses is to protect the primary of transformers. When selecting a fuse to be installed at the primary terminals of a transformer, all application rules concerning voltage rating and interrupting rating as mentioned in previous sections should be followed. This section is concerned primarily with the selection of the fuse continuous current rating. Details discussed in this section will be general. A more detailed discussion of how the fuse continuous current rating should be determined is given in Appendix 1.

Fuses at the primary of a transformer should not blow on transformer magnetizing or in-rush current, nor should they blow or deteriorate under long duration overloads to which the transformer is subjected in normal service and in cases of emergency. On the other hand, they must protect the transformer against short circuits. These considerations usually determine the upper and lower limit of the fuse rating. Coordination with other protective devices on the system, such as secondary breakers, often places further restrictions on the fuse to be selected. In general, however, a knowledge of transformer type allows the fuse continuous current rating to be chosen on the basis of a multiple of full load current.

Table 5: Continuous Current Ratings Available in Cutler-Hammer Expulsion Fuses

Max Design kV	RBA-RDB-200 Standard	RBT-200 Time Lag	RBA-RDB-400 Standard [Ⓢ]	RBT-400 Time Lag	DBU Standard	DBU Slow	DBU K-Rated	DBA-1, 2 Standard
2.75 5.50 8.25	10E to 200E 10E to 200E 10E to 200E	20E to 200E 20E to 200E 20E to 200E	0.5E to 400E1 0.5E to 400E1 0.5E to 400E1	20E to 400E1 20E to 400E1 20E to 400E1				0.5E to 200E
14.40 15.50 25.50 38.00	10E to 200E 10E to 200E 10E to 200E 10E to 200E	20E to 200E 20E to 200E 20E to 200E 20E to 200E	0.5E to 400E1 0.5E to 400E1 0.5E to 300E2 0.5E to 300E2	20E to 400E1 20E to 400E1 20E to 300E2 20E to 300E2	5E to 200E 5E to 200E 5E to 200E 5E to 200E	15E to 200E 15E to 200E 15E to 200E 15E to 200E	3K to 200K 3K to 200K 3K to 200K 3K to 200K	0.5E to 200E 0.5E to 200E 0.5E to 200E 0.5E to 200E

[Ⓢ] Using the 2 paralleled 800 fuse design, which has a 10% derating factor, ratings of 450, 540 and 720 are available.

Figure 4: Typical Fuse Coordination

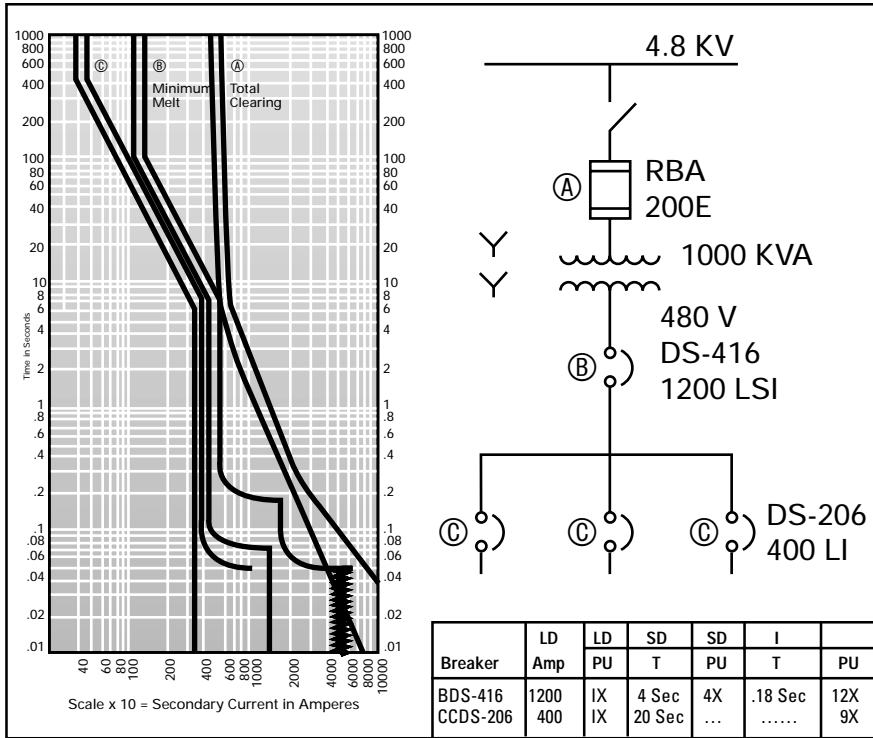

In the routine process of applying fuses on the basis of transformer KVA rating, it is assumed that adequate secondary protection is provided. The ordinary procedure then is to employ a fuse rating such that overheating due to inrush or permissible overloads does not damage the fuse. Assuming the transformer to be protected is self-cooled and that the maximum 1.5 hour overload on the transformer would not exceed 200 percent of the transformer rating, then the minimum ratio of fuse current rating to transformer full load current should be 1.2:1.

Thus, a fuse rating is chosen by multiplying the transformer full load rating by 1.4 and then selecting the fuse which has a continuous current rating of that value. If there is no fuse rated exactly 1.4 times the transformers full load rating, the next larger rated fuse should be selected.

Tables (7A) and (7B) give suggested fuse ratings for single phase and three-phase power transformers based on the 1.4:1 ratio given above.

It should be remembered that the 1.4:1 ratio is a general value, which may be varied, in specific cases. Dry type transformers, for instance, have a smaller overload capacity and permit fusing closer to the full load rating while distribution transformers are traditionally overloaded more severely and could require a fusing ratio as large as 2:1. Further, if provisions are made by thermal relays or otherwise to limit transformer overloads to a lower range, the ratio can be reduced. If a transformer has provisions for forced cooling, then the application ratio should be 1.2:1 for the fuse rating to the forced cooled rating.

Magnetizing inrush is the other factor the fuse must be able to withstand without damage. The magnitude of inrush may vary but, in general, is of magnitude 12 times the transformer full load rating for a 1/10 of a second duration. Inrush should not present a problem for any applications using a ratio as low as 1:1. If, however, there are any extenuating circumstances or

questions, then refer to the appropriate time-current curves and check to see that the inrush, magnitude and duration never cross the fuses' minimum melting curve.

Remember that a fuse must not be applied where it can realize a continuous current greater than its rating and that the fuse may not provide protection for currents in the range of one or two times the continuous current rating. Refer to the continuous current section or Appendix 1 for further information.

Capacitor Application

Another common use of power fuses is for the protection of capacitor banks. This application is unique in that the protected equipment, capacitors, are designed with a zero minus tolerance and some value of positive tolerance. For this reason a ratio of 1.65:1 fuse rating to full load current is suggested for all single bank protection. If two or more banks are paralleled with automatic switching, refer to the Technical Center for fusing information.

Repetitive Faults

It is often desirable to determine the performance of fuses under repetitive faults such as produced by the operation of reclosing circuit breakers. This performance is determined by graphically simulating the fuses' heating and cooling characteristics, which are found in and expressed by the melting time-current curves. The theory behind the above implications is available upon request, but in this section only the practical use of those implications will be discussed.

Conventional 'E' rated fuses can with good approximation be regarded as bodies whose heating and cooling properties are described by the basic exponential curves A and B as shown in Figure (6). Except for

being inverted, the cooling curve is the same as the heating curve as both have the same time constant. Each fuse has a specific time constant which can be calculated with sufficient accuracy by the formula $\theta = .1S^2$ where S is the melting current at .1 seconds divided by the melting current at 300 or 600 seconds. The 300 seconds applies for fuses rated 100 amperes or less and the 600 seconds for fuses rated above 100 amperes.

The time constant of a specific fuse, having been obtained in terms of seconds, gives to the general heating and cooling curves of Figure (6) a specific time scale. It enables us to plot the course of the fuse temperature (in percent values) if we know the sequence and duration of the open and closed periods of the recloser. This is illustrated by Curve C that is formed by piecing together the proper sections of Curves A and B.

Next we must determine the temperature at which the fuse will melt. Here we refer to the standard time-current curves and find the melting time M for a specific value of fault current. The melting temperature T_m lies where the ordinate to the time M intersects Curve A. It is not necessary to know the absolute value of this

temperature, as it is sufficient to know its relation to the peaks. A similar temperature T_n can be found using the total clearing time for the specific fault current. What we have then are two temperatures where we can state that any time the fuse Curve C intersects line T_m , the fuse could blow and any time it intersects line T_n , the fuse will definitely blow. The gap between T_m and T_n indicates the tolerance range as set forth in ANSI and NEMA standards where 'E' rated fuses are defined.

If the fuse is not to blow, Curve C must remain below the level T_m by a safe margin. It is common practice to provide such a safety margin by coordinating the breaker with a fuse curve whose time ordinates are 75 percent of those of the melting curve. Line T_s represents this temperature on Figure (6).

Although the construction of the temperature diagram as outlined above basically offers no difficulties, the manipulation is made easier and more accurate by putting the graph on semi-log coordinates as shown in Figure (7). On these coordinates the cooling curve B becomes a straight line.

Figure 5: Nature of Expulsion Fuse Discharge

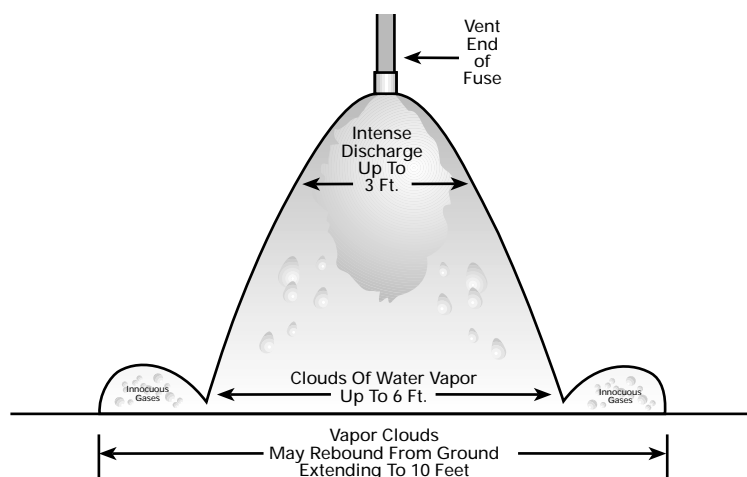

APPENDIX 1 Transformer Application

This appendix is to supplement the information presented in the "Transformer Application" section of this catalog. If general information is all that is required, then the section in the body of the "Transformer Application Data" should be sufficient. This appendix is an extension of that section and is more specific and detailed.

When selecting fuses to be installed at the primary terminals of a transformer, an understanding of the purpose of the fuse will aid in understanding the selection process. The purposes of the fuse in the order of their importance are as follows:

- Protect the system on the source side of the fuses from an outage due to faults in or beyond the transformer.
- Override (coordinate with) protection on the low-voltage side of the transformer.

- Protect the transformer against bolted secondary faults.
- Protect the transformer against higher impedance secondary faults to whatever extent is possible.

The selection process involves choosing the proper voltage, interrupting and continuous current ratings for the fuse. Application rules pertaining to voltage and interrupting rating are straightforward and are sufficiently covered in their respective sections. Selecting the fuse continuous current rating, which best fulfills the purpose hierarchy listed above can be more involved and will be discussed in detail in this section, due to faults in or beyond the transformer.

There are two major areas of concern when selecting a continuous current rating for the fuse, which is to protect a transformer. The rating must be large enough to prevent false or premature fuse interruption from magnetizing or inrush currents and it must also be large enough to

prevent fuse damage or fuse interruption during normal or emergency overload situations. Remembering the above restrictions, the fuse rating must also be small enough to provide the protection listed in the purpose hierarchy. Inrush, overloading and suggested minimum and maximum ratings will be the topic of the remainder of the appendix.

Fuses on the primary side of transformers should not blow on transformer magnetizing or inrush current. The magnitude of the first loop of inrush current and the rate at which the peaks of subsequent loops decay is a function of many factors. They are transformer design, residual flux in the core at the instant of energization, the point on the voltage wave at which the transformer is energized and the characteristics of the source supplying the transformer. When energizing, the heating effect of the inrush current in an expulsion fuse can be considered equal to 12 times the transformer full load current flowing for 1/10 of a second. Thus, when selecting the current rating for fuses used at the primary side of a transformer, the fuse

Table 6: Recommended Spacings

Max. Design kV		RBA Disconnect		RBA Non-Disconnect		RDB		DBU	DBA
		200/400	800	200/400	800	200/400	800		
2.75	4.80	11.75	27.51	11.16	19.92	18.0	26.76	17.0	17.0
5.50	8.25	11.75	27.51	11.16	19.92	18.0	26.75	17.0	17.0
14.40	15.50	13.25	29.01	12.56	21.32	18.0	26.75	17.0	17.0
25.50	38.00	14.75	30.51	13.06	21.82	18.0	26.76	17.0	17.0
48.30	72.50	16.25	32.01	15.56	24.32	24.0	32.76	19.0	19.0
		20.25	...	19.56	...	30.0	38.76	23.0	23.0
		25.25	...	24.56	...	36.0	44.76	30.0	30.0
		33.0
		44.0

Max. Design kV	RBA Filter		RBA Condenser	RDB-200, DBU & DBA-1 Vented		RDB-400, 800 & DBA-2 Vented	
	7.5	8.5		17.5	22.0		
2.75	7.5	8.5	3.0	17.5	22.0		
4.80	7.5	8.5	3.0	17.5	22.0		
5.50	8.5	8.5	4.0	17.5	22.0		
8.25	8.5	8.5	4.0	17.5	22.0		
14.40	11.5	11.5	6.0	21.0	26.0		
15.40	11.5	11.5	6.0	21.0	26.0		
25.50	15.0	15.0	8.5	26.0	32.0		
38.00	19.5	19.5	12.0	33.0	42.0		
48.30 (DBA only)	40.0	54.0		
72.50 (DBA only)	54.0	84.0		

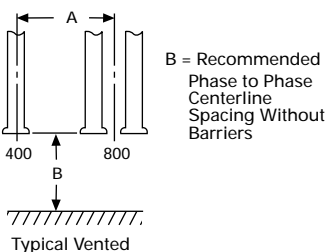
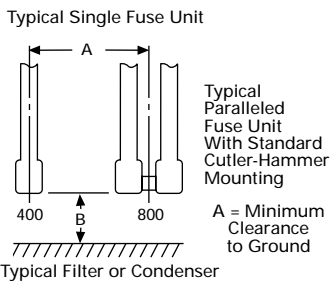

minimum-melting curve must lie above and to the right of the point on the time-current curve corresponding to 12 times full load current and 0.1 seconds. The fuse whose minimum melting curve lies just above and to the right of this point is the lowest rated fuse, which can be used at the primary terminals. This criterion is usually satisfied for all Cutler-Hammer expulsion fuses if the fuse current rating is equal to or greater than the transformer self-cooled full load current. Thus, a fusing ratio as low as 1:1 could be used in selecting primary side fuses if inrush or magnetizing current were the only concern.

It is common practice for most system operators to overload their transformers for short periods of time during normal and emergency situations. To allow this flexibility, it is necessary to select a fuse that can carry the overload without being damaged. When this is taken into account, a fusing ratio higher than 1:1 is almost always required when applying fuses for transformer protection. The fuse emergency overload curve (Figure 2 in the Technical Section) along with a knowledge of the extent to which the transformer will be overloaded is used as a basis for determining the smallest fuse which can be applied. The fuse rating is determined by using the duration of the transformer overload on the overload curve (ordinate value) to obtain a multiple of current rating, which should not be exceeded. If the transformer overload current is then divided by the multiple obtained from the overload curve. The result is the minimum fuse current rating. Select the fuse rating which equals or, is just larger than, this value. The allowable time duration of the current in the primary side fuses during transformer overload should never exceed the values shown by the fuse overload curve in Figure 2.

Suggested minimum fuse sizes for protection of self-cooled transformers are given in Tables

Table 7A - Suggested Minimum Expulsion Fuse Current Ratings for Self-Cooled 2.4 to 12.0 kV Power Transformer Applications

Nom. kV	2.4		4.16		4.8		7.2		12.0	
Fuse Max. kV	8.3		8.3		8.3		8.3		15.5	
Transformer Full kVA Rating Self-Cooled	Full Load Current Amps	Fuse E-Ampere Rating	Full Load Current Amps	Fuse E-Ampere Rating	Full Load Current Amps	Fuse E-Ampere Rating	Full Load Current Amps	Fuse E-Ampere Rating	Full Load Current Amps	Fuse E-Ampere Rating

Three Phase Transformers

9	2.16	3E	1.25	3E	1.10	3E	0.72	3E	0.43	3E
15	3.60	5E	2.08	3E	1.80	3E	1.20	3E	0.72	3E
30	7.20	10E	4.20	7E	3.60	5E	2.40	5E	1.44	3E
45	10.80	15E	6.20	10E	5.40	10E	3.60	5E	2.16	3E
75	18.00	25E	10.40	15E	9.00	15E	6.00	10E	3.60	5E
112	27.00	40E	15.60	25E	13.60	20E	9.00	15E	5.40	10E
150	36.00	50E	20.80	30E	18.00	25E	12.00	20E	7.20	10E
225	54.00	80E	31.30	50E	27.20	40E	18.00	25E	10.80	15E
300	72.00	100E	41.60	65E	36.00	50E	24.00	40E	14.40	20E
500	120.00	200E	69.40	100E	60.00	100E	40.00	65E	24.10	40E
750	180.00	250E	104.00	150E	90.00	125E	60.00	100E	36.10	50E
1,000	241.00	400E	140.00	200E	120.00	200E	80.00	125E	48.10	80E
1,500	360.00	540E①	208.00	300E	180.00	250E	120.00	200E	72.00	100E
2,000	481.00	720E②	278.00	400E	241.00	400E	160.00	250E	96.20	150E
2,500	600.00	...	346.00	540E①	301.00	450E③	200.00	300E	120.00	200E
3,750	180.00	250E
5,000	241.00	400E

Single Phase Transformers

5	2.08	3E	1.20	3E	1.04	3E	0.69	3E	0.416	3E
10	4.17	7E	2.40	5E	2.08	3E	1.39	3E	0.832	3E
15	6.25	10E	3.60	5E	3.13	5E	2.08	3E	1.25	3E
25	10.40	15E	6.00	10E	5.20	10E	3.47	5E	2.08	3E
37	15.60	25E	9.00	15E	7.80	15E	5.21	10E	3.12	5E
50	20.80	30E	12.00	20E	10.40	15E	6.95	10E	4.16	7E
75	31.30	50E	18.00	25E	15.60	25E	10.40	15E	6.25	10E
100	41.70	65E	24.00	40E	20.80	30E	13.90	20E	8.32	15E
167	70.00	100E	40.00	65E	35.00	65E	23.20	40E	13.90	20E
250	104.00	150E	60.00	100E	52.00	80E	34.80	50E	20.80	30E
333	139.00	200E	80.00	125E	69.50	100E	46.30	65E	27.70	40E
500	208.00	300E	120.00	200E	104.00	150E	69.60	100E	41.60	65E
667	278.00	400E	160.00	250E	139.00	200E	92.60	150E	55.40	80E
833	347.00	540E①	200.00	300E	173.00	250E	115.50	200E	69.40	100E
1,250	521.00	720E②	300.00	540E①	260.00	400E	174.00	250E	104.00	150E

① Two (2) 300 E Ampere fuse refills used in parallel with 10% derating factor.
 ② Two (2) 400 E Ampere fuse refills used in parallel with 10% derating factor.
 ③ Two (2) 250 E Ampere fuse refills used in parallel with 10% derating factor.

(7A) and (7B) which are found in this Appendix. These tables were based on the premise that the maximum 1.5-hour overload on the transformer would not exceed 200 percent of the transformer rating. This overload condition requires that the minimum ratio of fuse current rating to transformer full load current is 1.4:1. Fuse sizes listed in Tables (7A) and (7B) are those which are just higher than 1.4 times the transformer full load current. If higher or longer

duration transformer overloads are to be permitted, a fuse with a higher continuous current rating may be required. The procedure described in the previous paragraph should then be used to find the smallest permissible fuse size.

If provisions are made, by thermal or other protective devices, to limit transformer overloads to a lower range, the ratio of fuse current to transformer full load current can be

Table 7B - Suggested Minimum Expulsion Fuse Current Ratings for Self-Cooled 13.2 to 34.5 kV Power Transformer Applications

13.2		13.8		14.4		22.9		23.9		24.9		34.5		System Nom. kV
15.5		15.5		15.5		25.5		25.5		25.5		38.0		Fuse Max. kV
Full Load Current Amps	Fuse E-Ampere Rating	Full Load Current Amps	Fuse E-Ampere Rating	Full Load Current Amps	Fuse Ampere Rating	Full Load Current Amps	Fuse Ampere Rating	Full Load Current Amps	Fuse Ampere Rating	Full Load Current Amps	Fuse Ampere Rating	Full Load Current Amps	Fuse Ampere Rating	Transformer kVA Rating Self-Cooled

Three Phase Transformers

0.40	3E	0.38	3E	0.36	1/2E	0.22	1/2E	0.21	1/2E	0.20	1/2E	0.15	1/2E	9
0.66	3E	0.62	3E	0.60	3E	0.38	3E	0.36	1/2E	0.35	1/2E	0.25	1/2E	15
1.32	3E	1.25	3E	1.20	3E	0.75	3E	0.72	3E	0.69	3E	0.50	3E	30
1.98	3E	1.88	3E	1.80	3E	1.14	3E	1.09	3E	1.04	3E	0.75	3E	45
3.30	5E	3.10	5E	3.00	5E	1.89	3E	1.81	3E	1.74	3E	1.25	3E	75
4.95	7E	4.70	7E	4.51	7E	2.84	5E	2.72	5E	2.60	5E	1.88	3E	112.5
6.56	10E	6.20	10E	6.01	10E	3.78	7E	3.62	5E	3.47	5E	2.51	5E	150
9.90	15E	9.40	15E	9.02	15E	5.68	10E	5.44	10E	5.21	10E	3.77	7E	225
13.10	20E	12.50	20E	12.00	20E	7.58	15E	7.25	10E	6.94	10E	5.02	7E	300
21.90	30E	21.00	30E	20.10	30E	12.60	20E	12.10	20E	11.60	20E	8.37	15E	500
32.80	50E	31.00	50E	30.10	50E	18.90	30E	18.10	25E	17.40	25E	12.60	20E	750
43.70	65E	42.00	65E	40.10	65E	25.30	40E	24.20	40E	23.10	40E	16.70	25E	1000
65.60	100E	62.00	100E	60.10	65E	37.90	65E	36.20	50E	34.70	50E	25.10	40E	1500
87.50	125E	84.00	125E	80.20	125E	50.50	80E	48.30	80E	46.30	65E	33.50	50E	2000
109.00	150E	104.00	150E	100.00	150E	63.10	100E	60.40	100E	57.90	80E	41.80	65E	2500
165.00	250E	156.00	250E	150.00	250E	94.70	150E	90.60	150E	86.60	125E	62.80	100E	3750
218.00	300E	210.00	300E	200.00	300E	126.00	200E	121.00	200E	116.00	200E	83.70	125E	5000

Single Phase Transformers

0.38	3E	0.362	3E	0.35	1/2E	0.22	1/2E	0.21	1/2E	0.20	1/2E	0.14	1/2E	5
0.76	3E	0.724	3E	0.69	3E	0.44	3E	0.42	3E	0.40	3E	0.29	1/2E	10
1.14	3E	1.085	3E	1.04	3E	0.66	3E	0.63	3E	0.60	3E	0.43	3E	15
1.90	3E	1.81	3E	1.74	3E	1.09	3E	1.05	3E	1.00	3E	0.72	3E	25
2.84	5E	2.71	5E	2.60	5E	1.64	3E	1.57	3E	1.50	3E	1.09	3E	37.5
3.80	7E	3.62	5E	3.47	5E	2.19	3E	2.09	3E	2.00	3E	1.45	3E	50
5.70	10E	5.43	10E	5.21	10E	3.28	5E	3.14	5E	3.01	5E	2.17	3E	75
7.60	15E	7.24	10E	6.94	10E	4.37	7E	4.18	7E	4.01	7E	2.90	5E	100
12.70	20E	12.10	20E	11.60	20E	7.31	10E	6.99	10E	6.70	10E	4.84	7E	167
19.00	30E	18.10	25E	17.40	25E	10.90	15E	10.50	15E	10.00	15E	7.25	10E	250
27.70	40E	25.20	40E	23.10	40E	14.60	20E	13.90	20E	13.40	20E	9.65	15E	333
38.00	65E	36.20	50E	34.70	50E	21.90	30E	20.90	30E	20.10	30E	14.50	20E	500
50.50	80E	48.20	80E	46.30	65E	29.20	40E	27.90	40E	26.80	40E	19.30	30E	667
63.50	100E	60.40	100E	57.90	80E	36.40	50E	34.90	50E	33.40	50E	24.10	40E	833
95.00	150E	90.60	125E	86.80	125E	54.70	80E	52.30	80E	50.10	80E	36.20	50E	1250

less than 1.4:1. To find the amount of reduction permissible without damage to the fuse, the procedure using the overload curve should be employed.

When the transformer has forced cooling, the minimum fuse size, which can be applied, should be based on the transformer top rating and the extent to which the transformer will be overloaded beyond the top rating.

It should be remembered that an 'E' rated expulsion fuse applied at the primary terminals of a transformer

might not provide protection of currents between one and two times the continuous current rating of the fuse. That is, for currents in this range which exceed the time limits shown by the fuse overload curve in Figure (2), the fuse may be damaged before the fusible element melts. In order to provide dependable overload protection for the transformer, protection must be applied on the secondary side of the transformer.

Up to now the discussion of fuses applied at the primary terminals of a transformer has been concerned

with the lower limit of continuous current rating, which can be safely applied. Equal concern should be given to the upper limit of continuous current rating, which will provide protection for the transformer. The extent to which the fuses are to protect the transformer against secondary faults is one of several factors, which determines the upper limit. Increasing the primary fuse size to allow for higher overloads decreases the protection afforded the transformer and vice-versa. Usually thru-fault protection is provided to the transformer by a

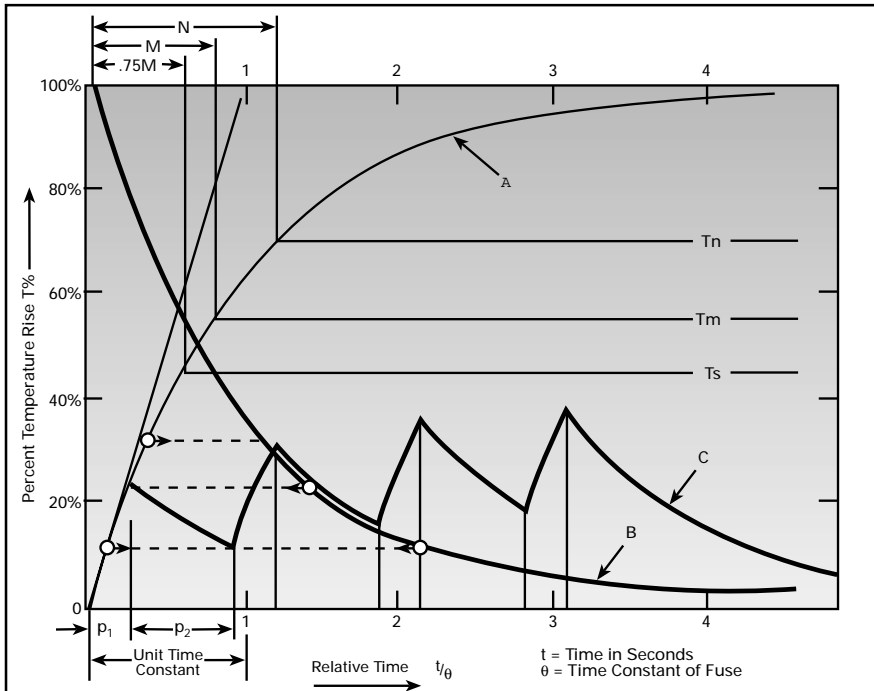

Figure 6: Temperature Cycle of a Fuse During Recloser Operation

Curve A - Basic fuse heating curve: $T = T_i (1 - 3 - t/q)$

Curve B - Basic fuse cooling curve: $T = T_i x e^{-t/q}$

Curve C - Temperature rise curve of fuse subjected to recloser cycle.

M - Melting time of fuse at a given fault current.

N - Total clearing time of fuse at same fault current.

T_m, T_n - Levels of melting temperature of fastest and of slowest fuse ①

T_s - Safe temperature level, considering service variables.

T_i - Hypothetical steady state temperature level (100%) attained if the fuse element did not open when melting temperature was reached but continued to be a resistance of constant value.

① The absolute temperature at which the elements of the fastest and of the slowest fuse melt is the same since both fuses are made of the same material. However, T_n and T_m are different if measured by the final temperature level T_i reached at a given current.

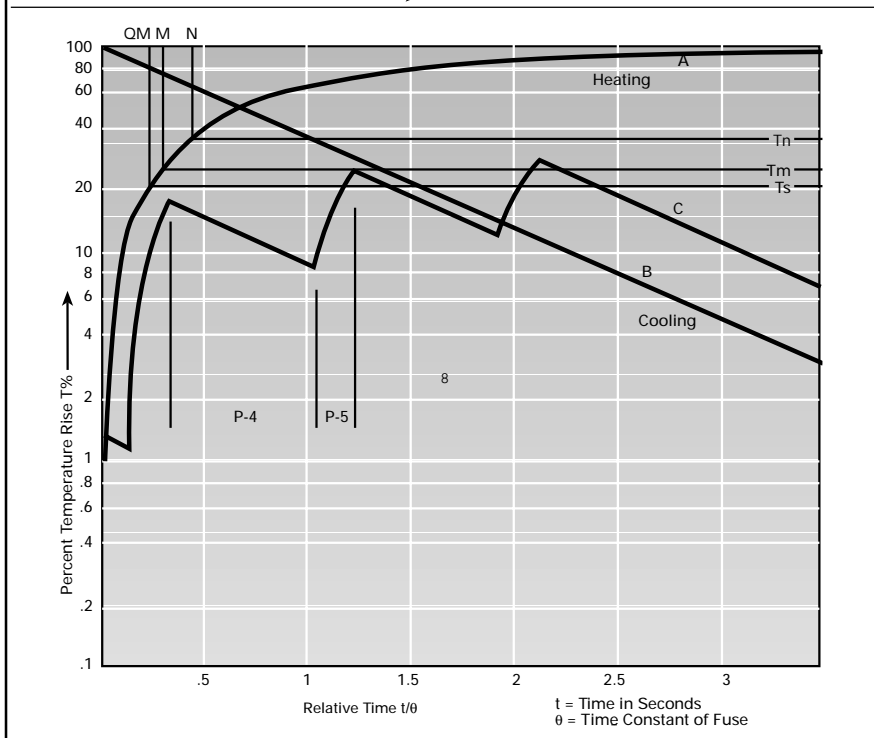

Figure 7: Reclosing Circuit Breaker - Fuse Coordination Chart

Recloser data: 400 PR 100 (cycling code A1-3CH3)
Fuse type and rating: RBA/RDB 400 - 150E standard speed.

Fuse speed ratio, S-2200/340=6.5
Thermal time constant, $q = .10 S_2, 4.2$ seconds.
Fault current 800 amps.

Period No.	Recloser t Closed	Timing Secs. Open	Total Time t	Relative Time t/q	Resulting % Temperature
1 ①	.054		.054	.013	1.31
2		.5	.554	.13	
3	.8		1.354	.32	
4		3.0	4.354	1.04	
5	.8	5.154	1.23		
6		3.0	8.154	1.23	
7	.8		8.954	2.13	28
Normal melting time			1.2	M=.29	$T_m=26$
$q \times M$.218	$T_i=20.5$	
Total clearing time			1.8	N=.43	$T_n=35.5$

① The first period may be so short that the intersection with curve A may be difficult to pinpoint. It should, therefore, be noted that, in Fig. 6, the initial portion of curve A coincides with the tangent which intersects the 100% level at the unit time constant. Consequently, the temperature level attained within such short times is determined simply by the formula $T\% = 100 \times t/q$.

② "q" is the coordination factor to take care of service variables. It is commonly estimated to be .75.

main secondary breaker or breakers and the main purpose of the primary fuses is to isolate a faulted transformer from the primary system. Although the primary fuses will isolate a transformer with an internal fault from the primary system, expulsion fuses generally

are not fast enough to prevent extensive damage to the transformer.

When a main secondary breaker is not used, the primary fuses may be the only devices which provide thru-fault protection for the transformer. In these

circumstances the fuse should operate before the transformer windings are damaged due to the heavy currents. The capability of transformer windings to carry these thru-fault or heavy currents varies from one transformer design to another. When specific information applicable to individual transformers is not available, the transformer 'heat curves' given in Figure (8) can be used to evaluate the thru-fault protection offered the transformer by the fuses. The curve labeled $N = 1$ is drawn through the points defined in IEEE/ANSI Appendix C57.92, Section 92-06.200 such that the curve has the same shape as shown in Figure 1 of IEEE publication 273 titled, 'Guide for Protective Relay Application to Power Transformers'. This curve applies to single-phase transformers and to three-phase faults on three-phase transformer banks. Curves for values of N other than 1 apply to unsymmetrical faults on three-phase transformers and three-phase transformer banks, which have at least one delta-connected winding. Ideally, the total clearing time-current of the primary fuse would lie below the 'heat curve' for all values of current up to 25 times the transformer rated current. However, as discussed earlier in this appendix, this is not usually possible as the fuse has minimum limitations placed on the rating due to long time overload impressed on the transformer and the fact that 'E' rated expulsion fuses do not generally provide protection for currents between one and two times their continuous current rating. In spite of these lower limitations, primary side fuses should protect the transformer for bolted secondary faults and higher impedance secondary faults to whatever extent is possible.

Wye-connected transformer windings, regardless of whether the neutral is or is not grounded or tied to the system neutral, have line currents which are equal to the winding currents for faults external

to the transformer. Thus a fuse connected to the terminal of a wye-connected winding will see the same current that is in the winding for all faults external to the transformer. This is not the case when the transformer has a delta-connected winding. With delta-connected windings the current in the lines (fuses) supplying the delta winding and currents in the delta windings generally are not equal, and of greater importance, the ratio of line (fuse) current to winding current varies with the type of fault on the external system. Consequently, a fuse connected to the terminal of a delta-connected winding will offer a degree of protection, which is a function of the type of fault on the external system.

The relationship between rated line (fuse) current and rated winding current (referred to, as the 'base current of the winding' in IEEE/ANSI C57.12.00 is 1 for wye connected primaries and divided by $\sqrt{3}$ for delta-connected primaries. IEEE/ANSI C57.12.00 also indicates that the transformer winding shall be capable of withstanding 25 times rated winding current for 2 seconds and smaller multiples of rated winding current for longer periods of time. However, transformer overloads and faults are generally expressed in terms of line and not winding current. This could present a problem for fault conditions where the type of fault changes the relationship between the line and winding current. Table (8) gives a multiplier, which will translate the line current in multiples of the winding current for different type

Figure 8: Transformer Heat Curves ①

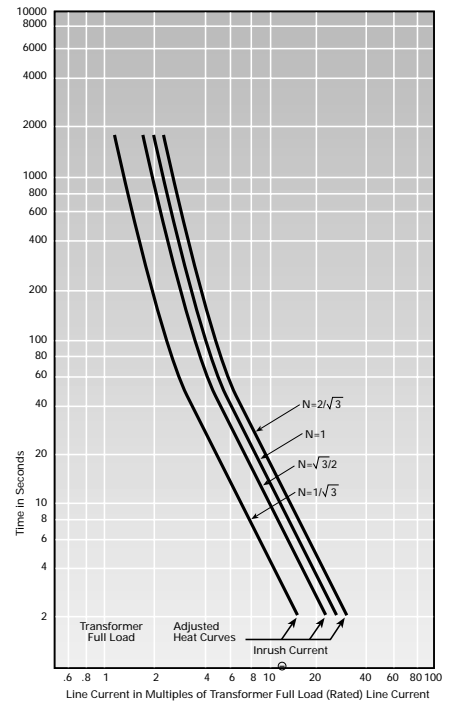

① Heat Curve for $N = 1$ drawn thru points listed in ANSI C57.92-06.200 and as shown in IEEE No. 273, Guide For Protective Relay Applications To Power Transformers.

faults for various transformer windings. This table leads us back to the transformer 'heat curves' shown on Figure (8) where it can be verified that the curve $N = 1$ passes through the point 25 times full load line current at 2 seconds. The curves for other than $N = 1$ are for unsymmetrical faults as can be seen from Table (8).

Coordination diagrams employ the transformer 'heat curves' and fuse time-current curves to determine

Table 8: Multiples of Primary Line Current for Fixed Secondary Winding Current

Transformer Connection All Neutrals Grounded		N (N times secondary winding current gives multiples of primary line current)		
Primary	Secondary	3 Phase Fault	Phase-To-Ground Fault	Phase-To-Phase Fault
Y	Y	1	1	1
Y	D	1	1
D	Y	1	1/√3	2/√3
D	D	1	√3/2

which fuse rating may be safely applied. These diagrams are the tools used to apply the information previously cited. The most straightforward diagram involves fuses applied at the terminals of transformers with wye primary windings. Table (8) shows that the fuse current is the same as the winding current for all faults external to the transformer. This means the coordination diagram consists simply of the direct reading of the fuse time-current curves and the transformer 'heat curve' $N = 1$ for coordination diagrams where the abscissa is labeled in amperes in the primary system. To coordinate with the abscissa labeled in secondary amperes the same two curves are shifted to allow for the ratio between primary and secondary amperes.

When fuses are employed at the terminals of a delta-wye transformer the coordination diagram becomes a bit more involved. In this instance Table (8) shows that the fuse current varies in relation to the winding current depending on the nature of the fault. Thus, when the coordination is with respect to primary amperes, the diagram consists of one direct reading fuse time-current curve and one or more transformer 'heat curves'. The number of 'heat curves' included would be determined by the types of secondary faults considered. Table (8) gives the N curve to be used for the different faults to be considered. When the coordination is with respect to secondary amperes the diagram consists of one transformer 'heating curve' ($N=1$) and up to three fuse time-current curves. The three time-current curves are again dependent on the possible faults to be considered. Table (8) shows that after the curve is translated to secondary amperes it must be shifted $1/\sqrt{3}$ when phase-to-ground faults are considered and $2/\sqrt{3}$ when phase-to-phase faults

are considered to obtain proper coordination.

Regardless of whether a primary or secondary current abscissa is employed, a coordination diagram for a delta-wye transformer shows that the primary side fuses do not protect the transformer for high-impedance secondary faults and overloads. This type of protection can be obtained through the application of secondary side breakers. If a secondary breaker were used it would be added to the coordination diagram by plotting the breaker phase and ground trip characteristics. Selective coordination would exist if the breaker phase trip characteristic curve lies below the fuse characteristic for a phase-to-phase fault and the 'heating curve', and the breaker ground trip characteristic for a single line-to-ground fault and the 'heating curve'.

The proceeding pertains to diagrams using secondary amperes. If the breaker characteristic is to be translated to primary amperes, its characteristics must lie beneath the fuse characteristic and the 'heating curve' for $N=1$. For unsymmetrical faults the breaker characteristic will shift by the same multiple as the 'heating curve'. If further secondary protection is translated to the primary, the characteristic must lie beneath the secondary breaker characteristic for the different types of faults considered.

Fuses used at the terminals of a delta-delta transformer require:

1. fuse time-current *and*
2. 'heating curves'

if both three phase and phase-to-phase faults are to be considered. This agrees with information presented in Table (8). When the abscissa is in primary amperes the curves are read directly. An abscissa in secondary amperes uses the same curves but shifts them from primary to secondary amperes.

For all the coordination diagrams discussed above, the vertical distance between the total clearing curve and the safe 'heat curve' indicates the margin of protection offered for different types of faults. It should be remembered, however, that the transformer 'heat curves' illustrated in this application data are drawn from the reference previously cited and they may not apply to all transformer designs.

The first part of this appendix pertained to the minimum fuse rating, which should be employed while the latter part was concerned with the maximum permissible rating. In practicality, it is not always possible to select a fuse large enough to allow for all the over-loading required and still provide complete protection for the transformer. In these cases, the user should decide where his priorities lie and trade off overloading ability for transformer protection.

RBA Fuses



Introduction

The Cutler-Hammer RBA (Refillable Boric Acid) Power Fuse is a vented, expulsion type power fuse designed for indoor or weatherproof enclosure applications. The RBA is a renewable (refillable) design. As the word renewable implies, the entire fuse unit is not discarded after it interrupts a fault. Usually, only one portion of the fuse, the refill, is replaced after an interruption. For this reason, RBA fuses provide an economical approach to the protection of distribution system equipment rated up to a maximum of 38 kV. They are especially well suited for large industrial load fusing needs.



An RBA is basically a vented electromechanical device designed for many different power applications. The RBA Power Fuse is most effective for higher operational voltage and higher continuous current requirements. The RBA expulsion type fuse, not unlike other similar devices, does not limit the magnitude of fault current during operation. It limits the duration of the fault on the electrical system.

RBA expulsion fuses are available in a wide range of ratings to simplify the selection process. They offer continuous current ratings of 1/2 through 720 amperes, maximum voltages of 8.3 through 38 kV, and symmetrical interrupting capabilities of 19,000 through 37,500 amperes. In addition, the RBA offers two operating time configurations, standard speed and time lag (delay). This feature, when combined with the wide range of ratings, permits customers to maximize both coordination and protection.

Since RBA Power Fuses can be used with either disconnect or non-disconnect mountings, fitting the fuse to the equipment type and layout restrictions is a simplified process. The RBA is an easy to install design and even easier to maintain.

Applications

In general, an electrical system consists of three major parts: generation, transmission and distribution. The distribution area offers an especially significant potential for RBA Power Fuse applications. This distribution system potential could be with the utility, an industrial or commercial user, or the manufacturer of electrical equipment.

Since the RBA Power Fuse is refillable (renewable), it is economical for use in a variety of indoor distribution system applications. Primarily, the RBA is designed for use on:

- Load Interrupter Switchgear
- Power Transformers
- High Voltage Capacitors
- Pad Mounted Transformers

The RBA can also be installed in fuse cabinets for both indoor and outdoor use.

RBA Power Fuses applied in a series combination with load break interrupter switches provide for reliable switching and fault protection. This type of equipment, commonly referred to as load interrupter switchgear, is an integrated assembly of switches, bus and fuses that are coordinated electrically and mechanically for effective circuit protection.

Another common application for RBA Power fuses is power transformer protection. Depending upon the transformer size and/or location, the RBA could be used to provide protection for the transformer's primary. Fuses applied here must be selected so as not to blow on such things as transformer inrush current while still providing protection against short circuits.

The RBA can also be used to protect capacitor banks. Capacitors require protection from fault currents which could cause a capacitor to rupture.

Protective equipment is also applied to the primary of pad mounted transformers to protect the upstream system from faults which occur in or beyond the transformer. Selection of the fuse type is dependent on many factors including: user or supplier preference, cost, and system coordination to mention a few. If the required voltage and continuous current ratings are high and downstream coordination is critical, RBA Power Fuses can provide very effective protection.

Operation and Features

In general, a complete renewable (refillable) indoor boric acid expulsion type fuse unit consists of the following major components:

- Boric Acid Refill
- Fuse Holder
- Mounting
- Optional Discharge Suppressor

The boric acid refill is a part of the fuse unit which is discarded after an interruption. It contains the fusible element which melts and a boric acid liner which assists with the interruption.

A boric acid refill is contained inside a tube called the fuse holder. The fuse holder holds the refill and provides electrical contact between the refill on the inside and the line/load connections on the outside.

Everything required to safely mount a fuse at its point of application is provided by the mounting. A fuse mounting consists of a metal base to which a number of other items are attached, such as insulators and current carrying parts. Mountings are usually available in non-disconnect and disconnect configurations. A non-disconnect mounting permanently mounts the fuse holder containing the refill with tension type fuse clips or bolted connections until it is completely removed. The disconnect mounting permits a fuse to be opened, closed or even lifted out of the mounting once it is opened. An insulated stick with a hook on the end of it is used to perform the opening and closing functions in a disconnect mounting. This insulated stick is referred to as a hookstick. Thus the frequently heard phrase - hookstick operated.

Depending upon the point of application, it is often necessary to attach a discharge suppressor (filter, condenser or muffler) to the fuse unit. This metallic device acts

to retard, to varying degrees, the gases and noise associated with an expulsion type fuse.

When the fuse element melts inside the refill, an arc is initiated and elongated. The heat of the arc decomposes the boric acid producing water vapor and boric anhydride. These two by-products extinguish the arc by blasting through it and exit from the bottom of the fuse. The gases are usually assisted with the interruption process by a spring loaded mechanical device located inside the fuse holder. In addition to the exhaust produced during interruption, a significant amount of noise also results. At this point, the previously mentioned suppressor is often used to limit this discharge and noise. What type of suppressor is installed depends upon the requirements at the point of application.

Typical Boric Acid Fuse Operation

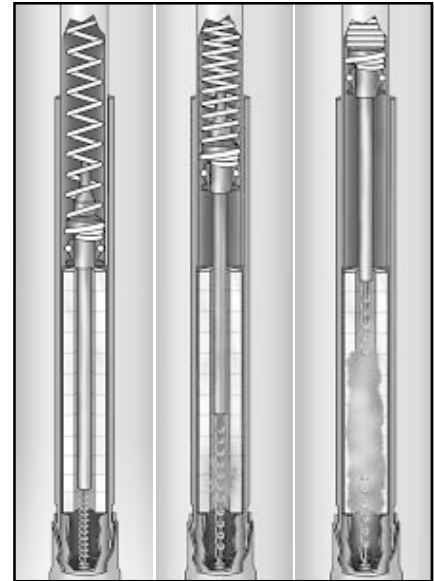

Typical Boric Acid Fuse with Muffler

RBA Details

The Cutler-Hammer renewable RBA fuse unit is not totally discarded after it interrupts a fault. This makes the RBA quite economical to use over time. Normally, only the fuse refill is discarded with the RBA design.

The RBA Power Fuse provides performance characteristics especially intended for distribution system protection up to an operational voltage of 34.5 kV. Because the RBA is available in a wide range of continuous current ratings and time-current characteristics, close fusing can be achieved, maximizing the protection and overall coordination. The quality and accuracy of the RBA design and manufacturing process ensures accurate initial and ongoing melting time-current characteristics. The proven RBA Power fuse performs as intended. It operates exactly when and how it should, and does not operate when it should not operate. This is a subtle but important point.

Each individual RBA fuse component, which is part of the total fuse package, is discussed individually. Its makeup and unique role in the protection process are also discussed.

RBA Refill

It is difficult to call one fuse component more important than another component, since all components must be combined in a coordinated package to function properly. If such a designation had to be made, however, the refill would have to be called the most important component. The term renewable is attributed to the refill, since it is the part of the fuse package that is replaced after an interruption. This replacement renews the fuse to its original state of protective readiness.

An RBA refill is comprised primarily of a conducting fuse element, an arcing rod, an auxiliary arcing wire,

a strain element, and a solid boric acid liner which assists with the interruption. One end of the fuse element is attached to the end cap of the refill tube and the other end is brazed to the main arcing rod. All of these components are contained within a separate fiberglass tube. The fiberglass tube has an end cap on one end with a blow-out disk which permits exhaust to exit during interruption. The other end of the tube permits one end of the arcing rod, which is threaded, to exit the refill tube. That end of the tube is sealed around the arcing rod where it exits from the refill tube.

The calibrated fuse element determines the operational time-current characteristics of the RBA fuse unit. It is sensitive to the heat produced by the amount of current flowing. How, when, or if it melts for different magnitudes of current

and amounts of time, a particular current magnitude experienced by the fuse is indicated on the specific time-current characteristic curve for a particular fuse. RBA fuse elements are available in standard and time-lag configurations. The standard element is made of silver and the time-lag of tin.

The heavy copper cylindrical arcing rod is contained within the main bore of the boric acid liner and performs two functions. Under normal operating conditions, it carries the continuous rated current of the fuse. When the fuse element melts during a fault condition, the arcing rod draws and lengthens the arc as it moves back into the boric acid liner. This backward movement is made possible because the arcing rod is under spring tension from the outside of the refill. The device causing the spring tension will be covered next in the RBA holder discussion.

A nichrome wire, called the strain element, parallels the fuse element and relieves the fuse element of any strain put on it by the spring loaded arcing rod. This high resistance wire shunts the fuse element and vaporizes immediately after the fuse element melts.

An auxiliary arcing wire is contained within the small bore of the boric acid liner. It plays a role in the proper operation of the fuse under all fault conditions. No load current is carried by the auxiliary wire.

RBA Refill Operation

Under fault conditions, the fuse element melts, the strain element melts, the arcing rod and arc are pulled back through the boric acid cylinder. Intense heat from the arc decomposes the dry boric acid. On decomposition, the boric acid forms water vapor and inert boric anhydride which extinguishes the arc by blasting through it and deionizing the arc. The exhaust caused by the interruption exits from the bottom of the fuse

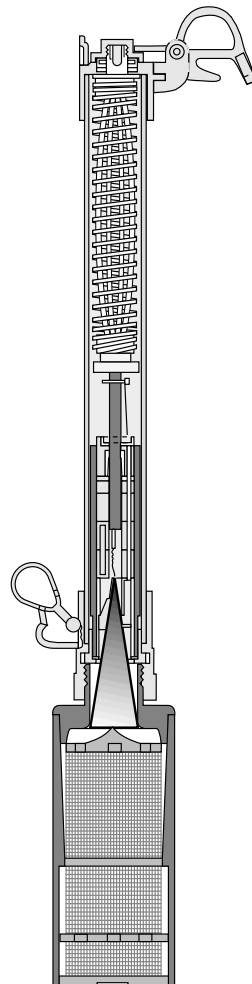

through the blow-out disk. This prevents the arc from re-striking after a current zero.

RBA refills are designed to interrupt short circuit currents within 1/2 cycle at current zero. Two different chambers in parallel within the solid boric acid liner provide for selective operation and interruption for both low current and high current faults utilizing the principles of De-Ionization.

Low Current Fault Operation

When a low current fault occurs, the main fuse and strain elements blow. The auxiliary wire shorts out the main fuse and the arc is extinguished in the small bore of the boric acid liner. The arcing rod, drawing no arc, moves back to an open position because of the spring tension.

High Current Fault Operation

A high fault current blows the main fuse and strain element and transfers to the auxiliary fuse wire. In the small bore, the arc creates a high voltage so it restrikes in the main bore. The arcing rod then draws the arc through the main bore where it is quickly extinguished.

RBA Refill Ratings

RBA fuse refills are ANSI/IEEE "E" rated. The "E" rating is a current response definition that was intended to produce a degree of electrical interchangeability among fuse manufacturers. Rather than having just a pure current rating for a fuse, the refill has its ampere rating stated in terms of a number followed by the capital letter E, 100E for example. A 100E fuse carries 100 amperes or below continuously and will melt in a defined amount of time for a defined range of current above the fuse's continuous current magnitude. This performance would be the same for all manufacturers with the "E" designation.

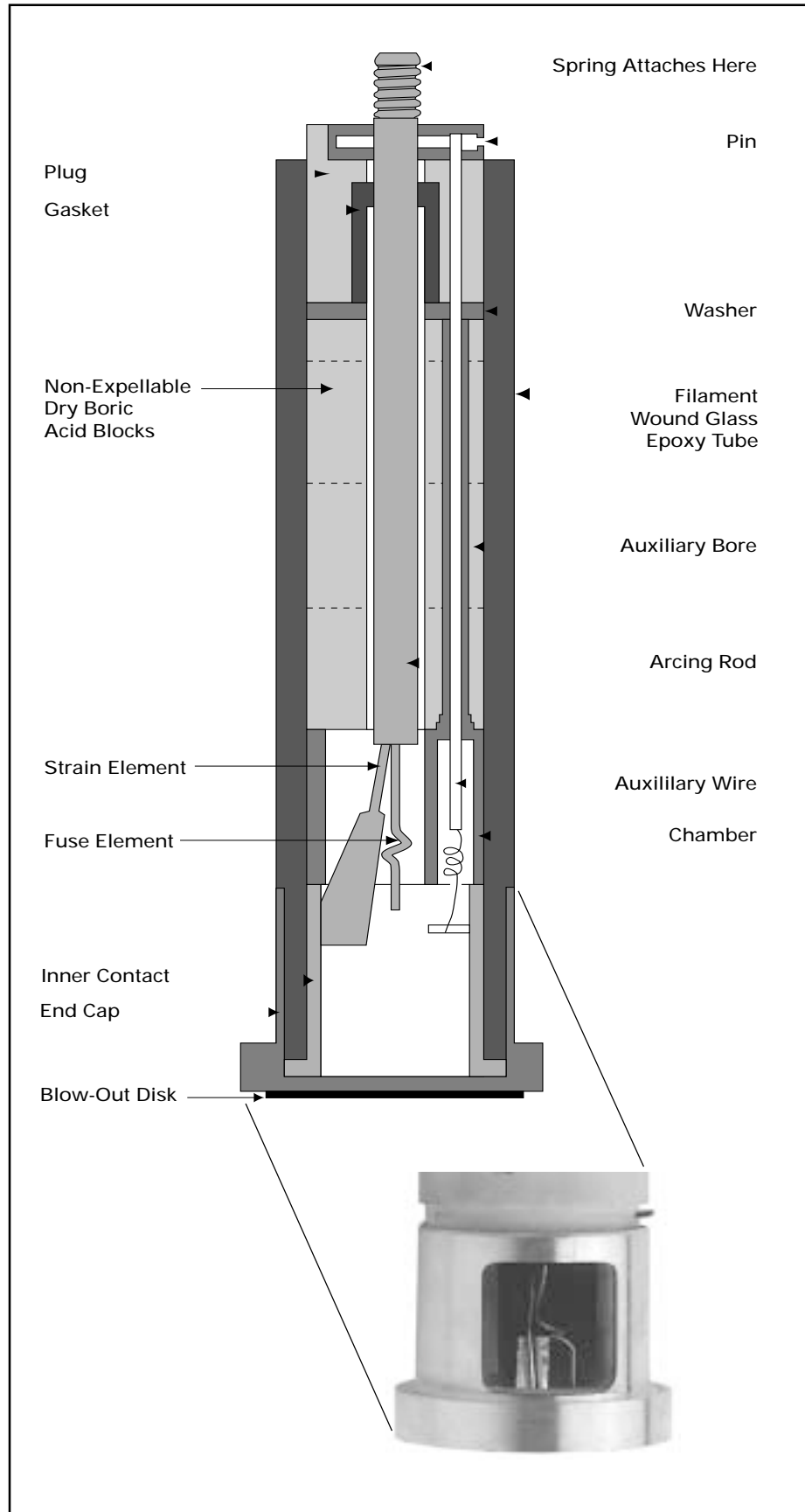

RBA Holder

An RBA fuse holder is a glass epoxy tube which encloses and supports the fuse refill. It also includes a spring and shunt assembly, provides for electrical connections, and includes the required hardware for use with a non-disconnect or a disconnect mounting. The holder delivers excellent dielectric strength as well as mechanical strength for support purposes. The RBA holder is not suitable for use in outdoor applications.

After a fuse unit performs its function by operating, the fuse holder is removed from the mounting, opened, and only the fuse refill is replaced. The fuse unit can then be once again put back into operation.

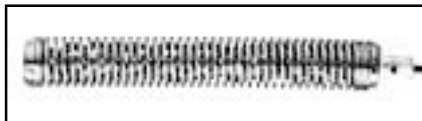

Spring and Shunt Assembly

A spring and shunt assembly is comprised of a helical spring which encloses a flexible, braided copper wire called the shunt. This assembly attaches on one end to the threaded end of the refill just discussed, and on the other end to the top contact of the holder. Once the spring and shunt assembly are properly attached and enclosed in the holder, the refill's arcing rod is put under spring tension and ready to operate by providing the required force to move the rod inside the refill up into the boric acid liner.

The flexible wire shunt inside the spring is an excellent conductor that completes the current path between the arcing rod and the top contact of the holder. Shunting or bypassing the helical shaped spring so the spring does not have to carry current requires the wire shunt to be very flexible. This flexibility is required to avoid any entanglement between the wire shunt and the spring which could impede movement of the arcing rod being

pulled by the spring during operation.

Holder Contacts and Hardware

The upper and lower contacts of the fuse holder provide the means for making electrical connections between the fuse refill and the mounting. They are often referred to as end fittings, since they attach to each end of the fuse holder. The hardware is made of silver plated cast bronze ensuring good electrical contact between the mounting and fuse itself. In addition, the electrical contacts also function to dissipate heat while the fuse is conducting electricity.



The only difference between non-disconnect and disconnect type fuse holders is the type of electrical contacts attached to the fuse holder. Disconnect electrical hardware permits the fuse to be hookstick-operated in a compatible disconnect type mounting. A hookeye is provided at each end of the fuse holder's disconnect hardware to accommodate the hook end of a hookstick opening and removal device. Non-disconnect electrical hardware requires the fuse unit to be held in a permanent position until completely removed from a compatible mounting.

RBA Mountings

Non-disconnect and disconnect mountings are both available for an RBA Power Fuse. A mounting provides everything necessary to safely mount a compatible RBA fuse unit to or in the applicable equipment. The mounting base is the metal support to which all the mounting parts attach. Porcelain or glass polyester insulators are attached to the base and insulate the live fuse unit and any other live part from the mounting base and everything beyond the base. Live parts, which are attached to the insulators, hold the fuse unit in place in the mounting, provide a place to make line and load connections, and are hot once electricity is flowing.

Live parts are available without the insulators or mounting base. Some applications have unique mounting situations or the customer may just choose to add additional value by supplying the insulators and base. It is still necessary to mount the live parts in a manner similar to that used with complete mountings. It is the customer's responsibility to make sure that all mounting requirements are met when using just the live parts.

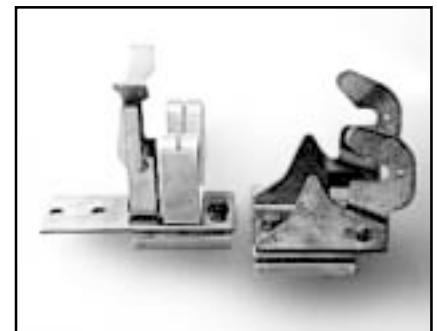
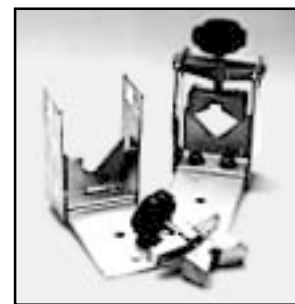

RBA non-disconnect mountings can be supplied in one of two configurations. RBA 200 and RBA 400 mountings use upper and lower fuse clips to hold the fuse unit in position under tension. The clips securely attach to both ends of the fuse holder. RBA 800 mountings hold the fuse unit in place by solidly bolting it into position. The type of non-disconnect mounting to be used depends upon the size and configuration of the fuse unit.

The RBA disconnect mounting is hookstick-operable which simplifies opening, closing, and fuse replacement. Not only is the hookstick used to open the fuse, it is used to lift the fuse from its mounting. This keeps the operator well clear of any live parts during fuse removal. One end of the mounting is the hinged end and one is the latched end. They work in conjunction with compatible disconnect parts attached to the fuse holder. Positive electrical connections are maintained at both ends of the mounting through the use of cadmium chromium copper spring fingers at the hinge end and clip type contacts on the break (latch) end. The spring fingers are compressed on closing in of the fuse holder. The current path is then made directly from the terminal pad to the fingers and the fuse holder. This upper end of the fuse holder is locked into position in the fuse holder by a stainless steel latch.

RBA Accessories

Optional accessory devices are often used with indoor expulsion fuses, like the RBA, to retard the gases and noise associated with this type of fuse during operation. Cutler-Hammer offers two devices called the condenser and the discharge filter. Other manufacturers might refer to such devices as suppressors or silencers. All of these devices act to retard, in varying degrees, the by-products of an interruption, much the same as an automobile muffler restricts the

by-products of internal combustion.

In cases where installation clearances are small, a condenser or a discharge filter can be threaded to the bottom of an RBA fuse holder to minimize the noise and exhaust while containing the arc within the fuse during interruption. Both devices are metallic containers with copper screen inside to absorb and dissipate arc heat and to condense steam to water. Although the inner and outer metals of the condenser and discharge filter are similar, the internal designs and venting methods are different.

The **condenser's design** fully restricts the expulsion process, which requires the interrupting rating (kA) of the fuse to be reduced when it is used with the RBA. Use of the discharge filter does not restrict the expulsion process enough to affect the interrupting rating of the fuse. A view of the bottom of both devices would easily identify which was the condenser and which was the discharge filter. The bottom end of the condenser is almost totally closed with one small weep hole for the release of water. On the other hand, the **discharge filter** has a number of larger holes. The application and installation location usually determines which device is selected.

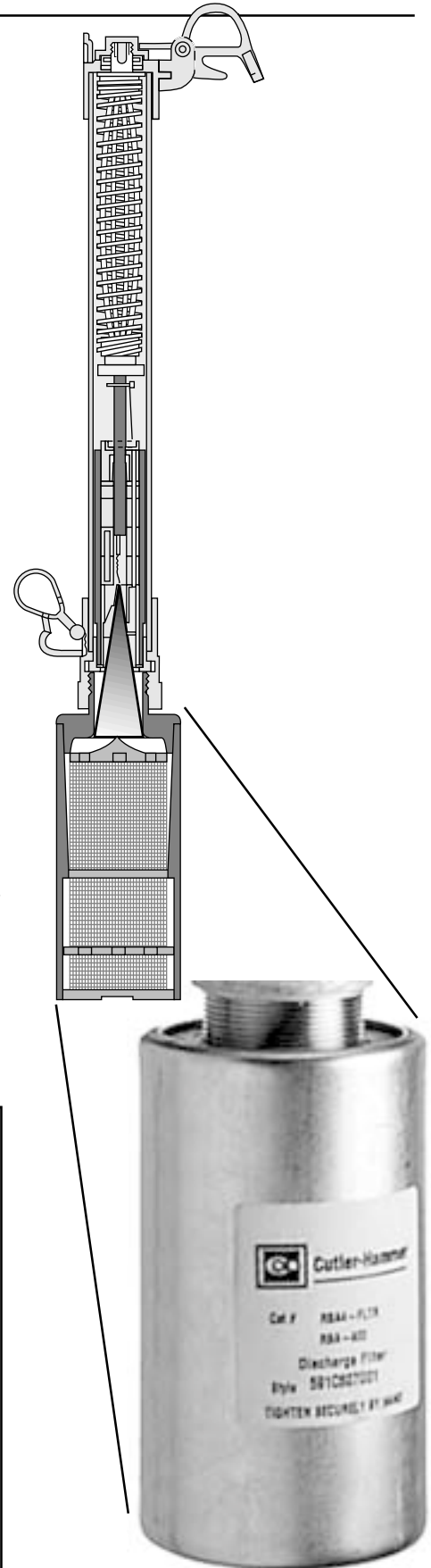
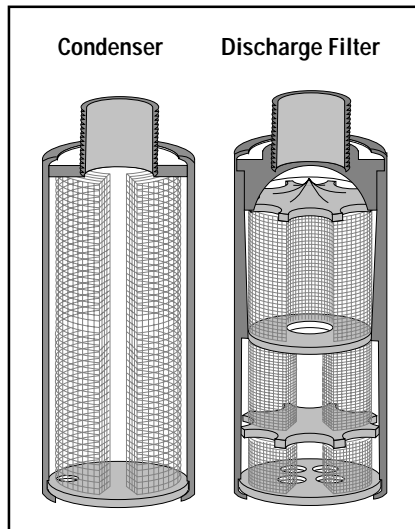

RBA Interruption and Protection

Up to this point, discussions have concentrated on the individual items that make up an RBA Power Fuse unit. Now the discussion will center around the complete RBA Power Fuse unit.

Together, the individual components discussed comprise a complete indoor RBA Power Fuse unit which provides effective protection for circuits and equipment which operate on voltages from 2400 through 34,500 volts.

The RBA Power Fuse has a long and enviable reputation for outstanding protection and reliability, broad selection possibilities, ease of installation and economy over time. At this point, it would be beneficial to briefly review the overall operation of an entire RBA Power Fuse unit.

An RBA Power Fuse unit, when mounted in a non-disconnect or disconnect mounting at its point of application, is positioned to perform its protective function as current flows through the mounting's line and load connectors. The RBA fuse holder makes the electrical connection with the mounting through its mounting hardware on each end of the holder. The holder's flexible shunt provides a current path to the refill which is enclosed by the holder. A spring loaded arcing rod, attached to the flexible shunt, carries the normal continuous current through the refill, and the circuit is operational. Under normal conditions, the fusible element's temperature rise is below its melting temperature and does not melt. When a fault occurs that is large enough to melt the fuse element inside the refill, an arc is initiated and elongated by the holder's helical spring pulling the arcing rod up into the boric acid interrupting media. The heat produced decomposes the boric

acid liner inside the refill producing water vapor and boric anhydride which helps to de-ionize the arc. These by-products extinguish the arc at a natural current zero by blasting through it and exiting out the bottom of the fuse. The exhaust and noise produced during the interruption process are limited by a condenser or discharge filter attached to the bottom of the holder. The RBA fuse unit, in most instances, is put back into operation after an interruption by removing the fuse unit from its mounting, replacing the refill inside the holder, and putting the fuse unit back into its mounting. Although the entire process is a bit more involved than just described, this should provide a general understanding of how the RBA Power Fuse works to provide outstanding and economical protection with limited down time.

During the interrupting process, current continues to flow in the circuit and in the fuse until a current zero is reached. When the arc is stopped at current zero, the voltage will do its best to reignite the arc. The voltage across the fuse terminals builds dramatically and is referred to as the transient recovery voltage (TRV). The TRV is the most severe waveform the fuse will have to withstand. This voltage build up puts a great deal of potentially destructive stress on the fuse unit and the system itself. Whether or not extinguishing of the arc is successful depends, in general, on the dielectric strength between the fuse terminals. In short, the dielectric strength between the fuse terminals must be greater than the voltage trying to reignite the arc for a successful interruption to occur. When properly applied, an RBA Power Fuse has a dielectric recovery that is more than a match for the TRV, regardless of the fault current

The **maximum voltage rating** of the RBA Power Fuse is the highest rms voltage at which the fuse is designed to operate. Its dielectric withstand level corresponds to

insulation levels of power class equipment, thus the name power fuse. Maximum voltage ratings for RBA Power Fuses are: 8.3, 15.5, 25.5 and 38.0 kV.

No fuse, including the RBA Power Fuse, should ever be applied where the available fault current exceeds the **interrupting rating** of the fuse. The rated interrupting capacity of the RBA is the rms value of the symmetrical component (AC component) of the highest current which the RBA is able to successfully interrupt under any condition of asymmetry. In short, the interrupting rating must be equal to or greater than the maximum symmetrical fault current at the point where the fuse is applied. The RBA has interrupting capabilities from 19,000 through 37,500 amperes symmetrical.

The **continuous current rating** of an RBA Power Fuse should equal or exceed the maximum load current where the fuse is applied. They are designed to carry their rated continuous current without exceeding the temperature rise outlined in NEMA and ANSI standards.

The RBA is available with continuous current ratings up to 720 amperes. The current ratings carry an "E" designation previously discussed and defined by ANSI and NEMA. For example, the current responsive element rated 100E amperes or below shall melt in 300 seconds at an rms current within the range of 200 to 240 percent of the continuous current rating. Above 100E amperes, melting takes place in 600 seconds at an rms current within the range of 220 to 264 percent of the continuous current rating.

Coordination considerations must be made to help determine what type of fuse is applied. The RBA Power Fuse interrupts at a natural current zero in the current wave and allows a minimum of a half cycle of fault current to flow before

the fault is cleared. The time-current characteristic associated with an RBA has a rather gradual slope making it easier to coordinate with downstream equipment. In addition, the RBA is ideal for higher voltage (through 38 kV) and higher current applications (through 720 amperes). Besides the voltage, interrupting current and continuous current considerations, it is important to examine the minimum melting and total clearing time-current characteristics of the particular fuse.

Finally, **low currents**, usually referred to as overload currents, must also be considered. The RBA and other expulsion fuses have a rather low thermal capacity and cannot carry overloads of the same magnitude and duration as motors and transformers of equal continuous currents. For this reason the fuse must be sized with the full load current in mind. This consideration should be made so the fuse does not blow on otherwise acceptable overloads and inrush conditions.

The **melting time** is the time in seconds required to melt the fuse element. This curve indicates when or even if the element of the fuse will melt for different symmetrical current magnitudes.

The Cutler-Hammer RBA family of power fuses is broad and comprehensive. Refer to the RBA Ratings Chart to review the ratings available for most conceivable application requirements. Keep in mind that the final selection process includes the selection of a refill, a holder, a mounting and any required accessories.

The **total clearing time** is the total amount of time it takes to clear a fault once the element has melted. The total clearing time is really the sum of the melting time and the time the fuse arcs during the clearing process.

The RBA Power Fuse is offered in two configurations for use with high currents: standard (fast) and time-lag (slow). The curves for the time-lag fuse are less inverse and allow for more of a time delay at high currents.

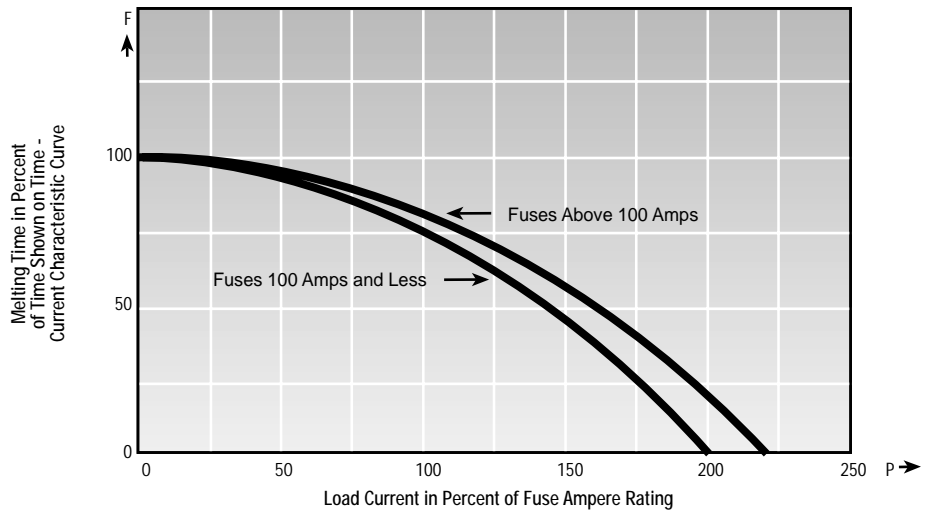
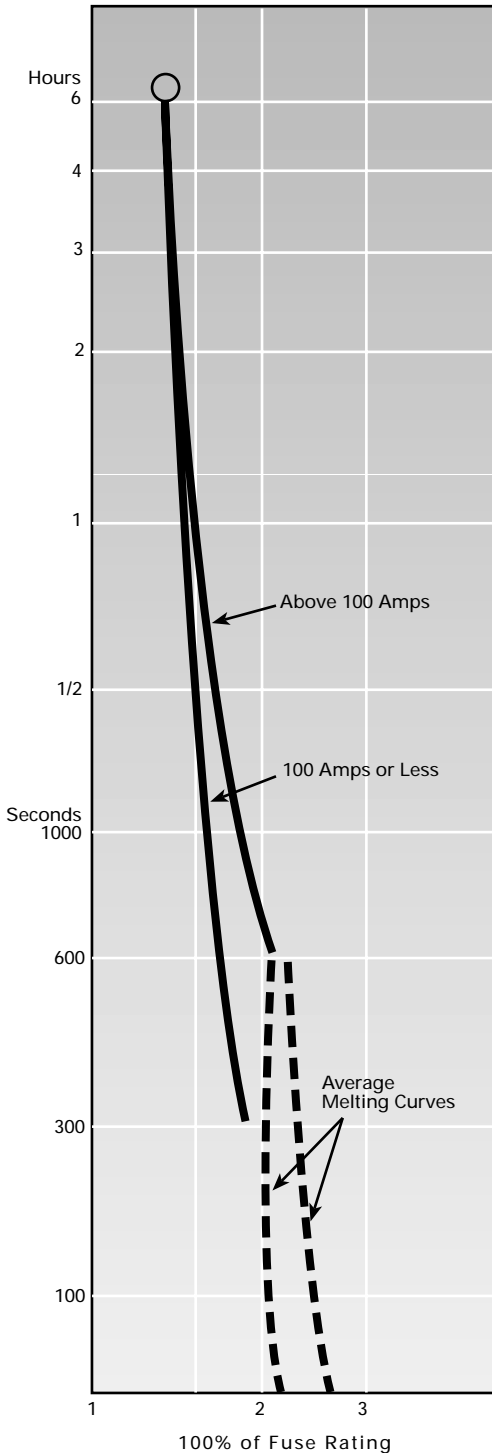

Ratings and Selection

The primary selection ratings, previously discussed, associated with an RBA expulsion type fuse are:

- Continuous Current Rating
- Maximum Voltage Rating
- Maximum Interrupting Current Rating

Cutler-Hammer RBA Power Fuses have three continuous current classes: 200A, 400A and 800A. They are designated the RBA-200, RBA-400 and RBA-800. In addition, the RBA is available with specific standard time or time lag current characteristics for more precise coordination.

The RBA-200 series offers current ratings of 10E to 200E. The RBA-400

series offers current ratings of 1/2E to 400E. Both of these RBA fuses are single barrel fuses. In other words, one fuse holder with one fuse refill inside the holder is used.

The RBA-800 series offers current ratings of 450, 540 and 720 amperes. It parallels two RBA-400 fuses, one fuse on the back of the other, to accomplish the higher continuous current ratings. This configuration is often referred to as a double barrel fuse. When two RBA-400 fuses are in parallel, the total continuous current rating is derated by 10 percent. For example, when two 400 ampere fuses are paralleled and the 10 percent factor applied, the result is the 720 amperes available as an RBA-800.

An RBA-800 series fuse is not only a double barrel fuse utilizing two fuse holders, two fuse refills and two

accessory devices (discharge filter or condenser), it requires a special mounting capable of holding this larger and heavier fuse. The mounting is often called a piggyback mounting since it holds two fuses that are attached back-to-back.

Each RBA current class is available in an operational voltage range from 2400 to 34,500 volts, with symmetrical interrupting ratings from 19,000 to 37,500 amperes. Refer to the RBA Ratings Chart for the wide range of selection possibilities.

Dimensional Details

To determine exact dimensions, phase spacing and minimum clearances, refer to the appropriate dimensional tables and outline drawings for the RBA fuse units selected.

RBA Power Fuse Ratings

RBA 200 - with Discharge Filter							
Maximum Design Voltage	8.3kV			15.5kV		25.5kV	38kV
Nominal Voltage	2.4kV	4.8kV	7.2kV	13.8kV	14.4kV	23.0kV	34.5kV
Symmetrical	19000A	19000A	16600A	14400A	14400A	10500A	6900A
Asymmetrical	30000A	30000A	26500A	23000A	23000A	16800A	11000A
Maximum X/R Ratio	15	15	15	15	15	15	15
Continuous Current-Std Speed	10 to 200A	10 to 200A	10 to 200A	10 to 200A	10 to 200A	10 to 200A	10 to 200A
Continuous Current-Time Lag	20 to 200A	10 to 200A	20 to 200A	20 to 200A	20 to 200A	20 to 200A	20 to 200A
RBA 200 - with Condenser							
Maximum Design Voltage	8.3kV			15.5kV		25.5kV	38kV
Nominal Voltage	2.4kV	4.8kV	7.2kV	13.8kV	14.4kV	23.0kV	34.5kV
Symmetrical	10000A	10000A	10000A	8000A	8000A	6300A	5000A
Asymmetrical	16000A	16000A	16000A	12800A	12800A	10100A	8000A
Maximum X/R Ratio	15	15	15	15	15	15	15
Continuous Current-Std Speed	10 to 200A	10 to 200A	10 to 200A	10 to 200A	10 to 200A	10 to 200A	10 to 200A
Continuous Current-Time Lag	20 to 200A	20 to 200A	20 to 200A	20 to 200A	20 to 200A	20 to 200A	20 to 200A
RBA 400 / RBA 800 - with Discharge Filter							
Maximum Design Voltage	8.3kV			15.5kV		25.5kV	38kV
Nominal Voltage	2.4kV	4.8kV	7.2kV	13.8kV	14.4kV	23.0kV	34.5kV
Symmetrical	37500A	37500A	29400A	29400A	29400A	21000A	16800A
Asymmetrical	60000A	60000A	47000A	47000A	47000A	33500A	26800A
Maximum X/R Ratio	15	15	15	15	15	15	15
Continuous Current-Std Speed RBA 400	1/2 to 400A	1/2 to 400A	1/2 to 400A	1/2 to 400A	1/2 to 400A	1/2 to 400A	1/2 to 400A
Continuous Current-Time Lag RBA 400	20 to 400A	20 to 400A	20 to 400A	20 to 400A	20 to 400A	20 to 400A	20 to 400A
Continuous Current-Std & Time Lag RBA 800	450 to 720A	450 to 720A	450 to 720A	450 to 720A	450 to 720A	450 to 720A	450 to 720A
RBA 400 / RBA 800 - with Condenser							
Maximum Design Voltage	8.3kV			15.5kV		25.5kV	38kV
Nominal Voltage	2.4kV	4.8kV	7.2kV	13.8kV	14.4kV	23.0kV	34.5kV
Symmetrical	20000A	20000A	16000A	12500A	12500A	10000A	10000A
Asymmetrical	32000A	32000A	25600A	20000A	20000A	16000A	16000A
Maximum X/R Ratio	15	15	15	15	15	15	15
Continuous Current-Std Speed RBA 400	1/2 to 400A	1/2 to 400A	1/2 to 400A	1/2 to 400A	1/2 to 400A	1/2 to 400A	1/2 to 400A
Continuous Current-Time Lag RBA 400	20 to 400A	20 to 400A	20 to 400A	20 to 400A	20 to 400A	20 to 400A	20 to 400A
Continuous Current-Time Lag RBA 800	450 to 720A	450 to 720A	450 to 720A	450 to 720A	450 to 720A	450 to 720A	450 to 720A

RBA Fuse Mountings - RBA 200,400 Disconnect Mountng - 4.8 to 34.5 kV

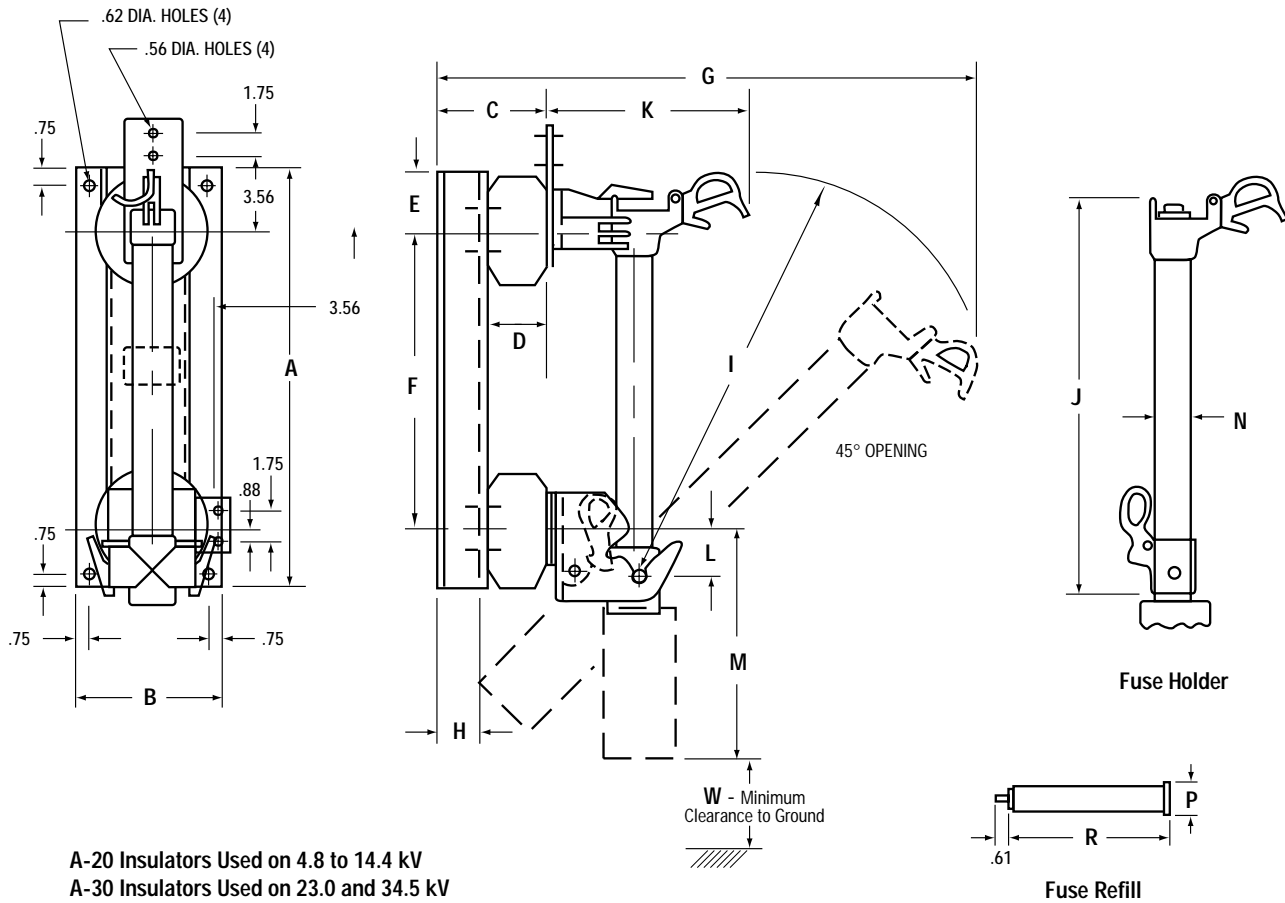

A-20 Insulators Used on 4.8 to 14.4 kV
A-30 Insulators Used on 23.0 and 34.5 kV

Catalog Number	kV BIL	Dimensions in Inches																	Recommended Phase Spacing ①	
		A	B	C	D	E	F	G	H	I	J	K	L	M	N	P	R	W		
		With Con- denser	With Dis- charge																	
5RBA2	60	22.62	7.00	7.50	3.50	5.87	14.25	27.19	3.34	18.69	18.81	9.25	1.56	10.12	1.64	1.50	7.50	3.00	7.50	11.50
8RBA2	75	22.62	7.00	10.00	6.00	5.87	14.25	29.69	6.34	18.69	18.81	9.25	1.56	10.12	1.64	1.50	7.50	4.00	8.50	13.00
14RBA2	95	22.62	7.00	10.00	6.00	2.62	17.62	32.12	6.34	22.06	22.19	9.25	1.56	10.12	1.64	1.50	8.75	6.00	11.50	14.50
15RBA2	110	22.62	7.00	11.50	7.50	2.62	17.62	33.62	7.84	22.06	22.19	9.25	1.56	10.12	1.64	1.50	8.75	6.00	11.50	16.00
25RBA2	150	33.88	8.00	12.00	10.50	2.50	22.25	37.69	11.71	26.69	26.81	9.25	1.56	10.12	1.64	1.50	10.50	8.50	15.00	20.00
38RBA2	150	33.88	8.00	12.00	10.50	2.50	29.25	42.62	11.71	33.69	33.81	9.25	1.56	10.12	1.64	1.50	13.12	12.00	19.50	25.00
5RBA4	60	22.25	7.00	7.50	3.50	5.94	13.81	27.40	3.03	19.69	20.00	9.25	2.63	11.75	2.17	2.20	7.62	3.00	7.50	11.75
8RBA4	75	22.25	7.00	10.00	6.00	5.94	13.81	29.90	5.53	19.69	20.00	9.25	2.63	11.75	2.17	2.20	7.62	4.00	8.50	13.25
14RBA4	95	22.25	7.00	10.00	6.00	2.56	17.19	32.81	5.53	23.69	23.38	9.25	2.63	11.75	2.17	2.20	8.88	6.00	11.50	14.75
15RBA4	110	22.25	7.00	11.50	7.50	2.56	17.19	34.31	7.03	23.69	23.38	9.25	2.63	11.75	2.17	2.20	8.88	6.00	11.50	16.25
25RBA4	150	33.81	8.00	13.50	10.50	2.50	21.81	39.56	9.03	27.69	28.00	9.25	2.63	11.75	2.17	2.20	11.38	8.50	15.00	20.25
38RBA4	150	33.81	8.00	13.50	10.50	2.50	28.81	44.50	9.03	34.69	35.00	9.25	2.63	11.75	2.17	2.20	13.62	12.00	19.50	25.25

① Phase-to-phase center spacing, without barriers.

RBA-200 RBA-400 and RBA 800 (Piggy Back Type) - Non-Disconnect Mounting 4.8 to 34.5 kV

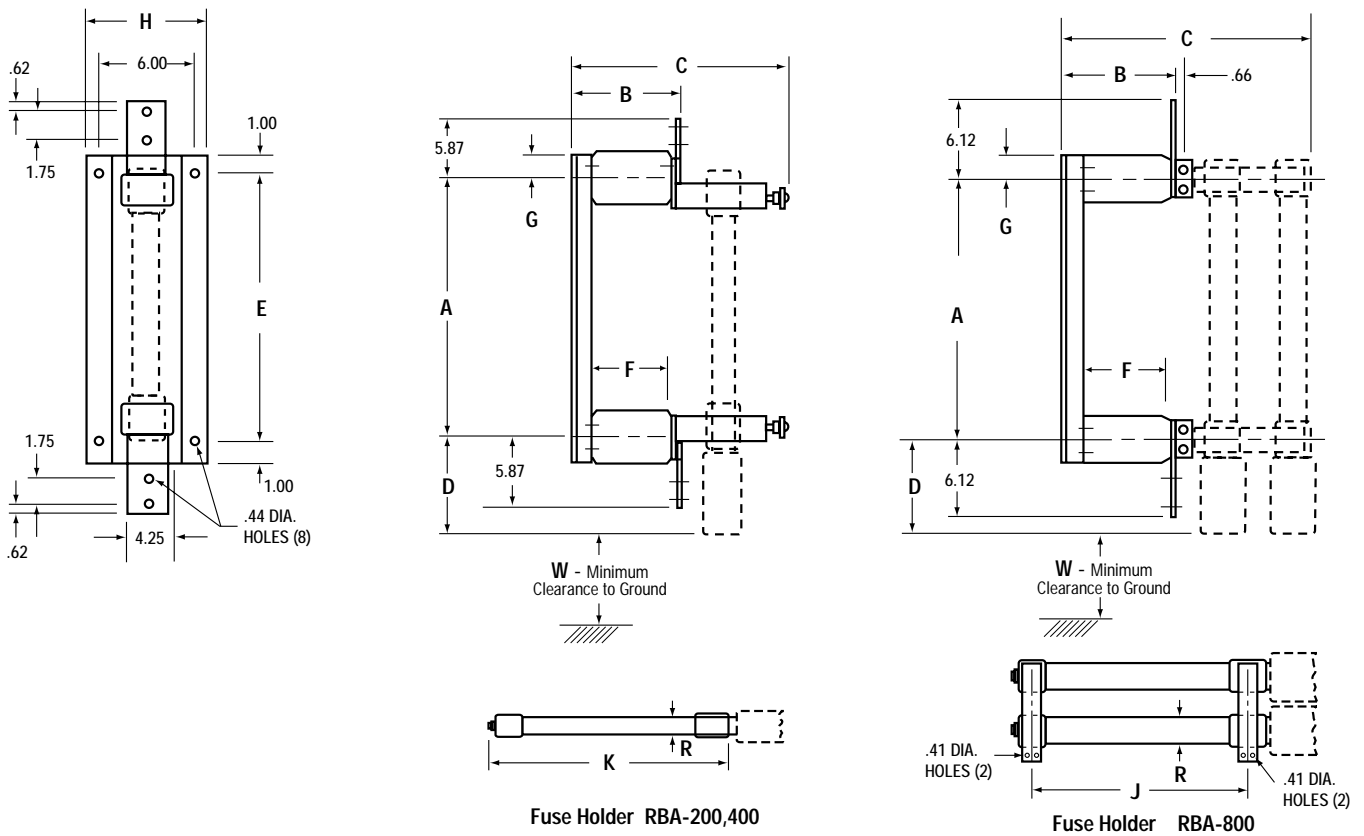

Catalog Number	kV BIL	Dimensions in Inches													Recommended Phase Spacing ^②
		A	B	C	D	E	F	G	H	J	K ^②	R	W		
		With Con- denser	With Dis- charge												
5RBA2	60	15.62	4.62	11.43	8.62	15.62	7.50	1.32	7.50		18.25	1.64	3.00	7.50	11.16
8RBA2	75	15.62	7.12	13.93	8.62	15.62	7.50	1.32	7.50		18.25	1.64	4.00	8.50	12.56
14RBA2	95	19.00	7.12	13.93	8.62	19.00	7.50	1.32	7.50		21.63	1.64	6.00	11.50	13.06
15RBA2	110	19.00	8.62	15.43	8.62	19.00	7.50	1.32	7.50		21.63	1.64	6.00	11.50	15.56
25RBA2	150	26.43	12.12	18.93	7.25	29.43	8.50	2.50	8.50		26.25	1.64	8.50	15.00	19.56
38RBA2	150	33.43	12.12	18.93	7.25	36.43	8.50	2.50	8.50		33.25	1.64	12.00	19.50	24.56
5RBA4	60	16.56	4.62	12.31	8.75	16.56	7.50	1.32	7.50		19.52	2.17	3.00	7.50	11.16
8RBA4	75	16.56	7.12	14.81	8.75	16.56	7.50	1.32	7.50		19.52	2.17	4.00	8.50	12.56
14RBA4	95	19.94	7.12	14.81	8.75	19.94	7.50	1.32	7.50		22.90	2.17	6.00	11.50	13.06
15RBA4	110	19.94	8.62	16.31	8.75	19.94	7.50	2.50	7.50		22.90	2.17	6.00	11.50	15.56
25RBA4	150	27.37	12.12	19.81	7.37	30.37	8.50	1.32	8.50		22.90	2.17	8.50	15.00	19.56
38RBA4	150	34.37	12.12	19.81	7.37	37.37	8.50	2.50	8.50		34.52	2.17	12.00	19.50	24.56
5RBA8	60	16.31	4.50	12.85	9.31	17.56	3.50	1.62	3.50	16.31		2.17	3.00	7.50	11.00
8RBA8	75	16.31	7.00	15.35	9.31	17.56	6.00	1.62	6.00	16.31		2.17	4.00	8.50	12.50
14RBA8	95	19.81	7.00	15.35	9.31	21.06	6.00	1.62	6.00	19.81		2.17	6.00	11.50	14.00
15RBA8	110	19.81	8.50	16.85	9.31	21.06	7.50	1.62	7.50	19.81		2.17	6.00	11.50	15.50
25RBA8	150	24.50	11.50	19.85	9.31	27.50	10.50	2.50	10.50	24.50		2.17	6.00	15.00	19.50
38RBA8	150	31.50	11.50	19.85	9.31	34.50	10.50	2.50	10.50	31.50		2.17	12.00	19.50	24.50

^① Phase-to-phase center spacing, without barriers.
^② Approximate dimensions.

Testing and Performance

- Standards
- Testing
- Quality Standards

Cutler-Hammer does not compromise when performance, quality and safety are involved. Exacting standards have been established relative to the design, testing and application of expulsion type power fuses. Compliance with these standards ensures the best selection and performance.

Type RBA Power Fuses are designed and tested to applicable portions of ANSI standards as well as other industry standards. The ANSI standards are Consensus Standards jointly formulated by IEEE and NEMA.

IEEE (Institute of Electrical and Electronic Engineers) is an objective technical organization made up of manufacturers, users and other general interest parties. NEMA (National Electrical Manufacturers Association) is an electrical equipment manufacturer-only organization with members like Cutler-Hammer. ANSI (American National Standards Institute) is a non-profit, privately funded membership organization that coordinates the development of U.S. voluntary national standards. It is also the U.S. member body to the non-treaty international standards bodies, such as International Organization for Standardization (ISO) and the International Electrotechnical Commission (IEC).

The specific standards associated with RBA Power Fuses are:

- ANSI C37.40 - Service Conditions and Definitions
- ANSI C37.41 - Power Fuse Design and Testing
- ANSI C37.46 - Power Fuse Ratings and Specifications
- ANSI C37.48 - Power Fuse Application, Operation & Maintenance

Testing

RBA Power Fuse unit design testing was performed on standard production fuses, holders, mountings and accessories. Demanding tests were performed at the Cutler-Hammer Technical Center and also at recognized independent power testing laboratories. Thermal and interrupting testing was conducted at 8.3, 15.5, 25.5 and 38kV levels. The entire series of tests was conducted in a specific sequence as stipulated by governing standards without any maintenance being performed. All test results are verified by laboratory tabulations and oscillogram plots.

Quality

Every effort is made to ensure the delivery of quality fuse units and customer satisfaction. All Cutler-Hammer fuses are completely inspected at each manufacturing stage.

In addition to ongoing quality control inspections, testing is performed prior to shipment. A Micro-Ohm Resistance Test is performed on each fuse to assure proper element construction, alignment and tightness of electrical connections. Construction integrity testing is also performed on every unit.

Each RBA fuse unit is checked to ensure that all items are supplied in keeping with manufacturing drawings. Individual fuses are packed in a plastic bag and then put into individual cartons. In addition, fuses are overpacked in a shipping carton to prevent shipping damage. Finally, mountings are packaged in heavy cardboard containers with reinforced wooden bases.

Installation and Use

- Receiving
- Mounting Installation
- Refill and Discharge Suppressor Installation
- Fuse Holder Installation

Receiving

Large orders of fuse mountings and fuses could be shipped securely attached to a pallet. Although the use of a forklift to lift a pallet is not recommended, forklift provisions are provided. If a forklift is used, the forks must be extended through the skid to avoid damaging the equipment.

During receiving and installation of the equipment, care should be exercised so as to prevent damage and insure proper operation. Porcelain mounting insulators, for example, are quite strong but can be broken producing sharp edges that could compromise the electrical characteristics of the insulator.

Inspect each item carefully for any signs of shipping damage. Check all items against the manifest to ensure that the correct items and quantities are received. Keep in mind that refill instructions and a refill tool are provided with each fuse unit. Note any shortages or damage and file a claim immediately.

If any fuse, mounting or accessory is not intended for immediate use, it should remain in its original protective container and stored in a clean, dry place.

Mounting Installation

RBA disconnect mountings, non-disconnect mountings or other mounting hardware, such as live parts, should be securely mounted in keeping with instructions provided and the requirements of applicable standards and local codes. Good safety practices and electrical requirements should be strictly observed to insure a safe and functional installation.

Fuse mountings are completely assembled and gauged before shipment. This helps to simplify the installation and ensure correct operation. Prior to installation, check the mounting and the operation of its compatible fuse holder in the mounting.

When mounting the base, bolt it to the supporting structure utilizing the mounting holes provided. Use shims to prevent base distortion when bolting to an uneven surface. Connect conductors to the terminals so that stress is not put on the insulators. Proper torque should be maintained for the size of the bolts used. Once the mounting is installed, it should be rechecked in the same way it was checked before installation.

If live parts above the insulator are being mounted instead of a complete Cutler-Hammer mounting, it is the customer's responsibility to verify that the installation meets all electrical requirements and is installed properly.

Refill and Discharge Suppressor Installation

The Cutler-Hammer RBA Power Fuse is a replaceable design. After the fuse holder has been removed from the circuit or before it has been installed in a new installation, a new refill must be installed. Any discharge suppressors (discharge filter or condenser) which will be used must also be installed.

Whether installing a fuse refill or a discharge suppressor for the first time during an initial installation or replacing components after an interruption, the installation procedures are very similar. Remember a new refill is supplied complete with instructions and a refill tool. The refill tool is threaded at both ends to accommodate RBA-200 and RBA-400 refills.

Simple step-by-step instructions are provided for removing and replacing a used refill or installing a refill at a new installation.

Fuse Holder Installation

Since some fuse units can be rather heavy, especially when equipped with surge suppressors or of a piggyback configuration, it may be advisable to have assistance when removing or replacing certain fuse units. This is especially applicable to fuse units in non-disconnect type mountings.

RBA Disconnect: The RBA disconnect mounting is not intended to be a loadbreak device and should not be opened under load. RBA disconnect fuse holders are designed to be opened or closed and removed or replaced using a standard live-line tool. The hook on the end of the tool is inserted into the hookeye on the latch end and pulled sharply to open or pushed sharply to close and latch. Once in the open position, the hook is connected to the hookeye on the hinged end and used to lift the fuse unit upward and out of its mounting. Similarly, the fuse unit can be placed into its mounting and closed by reversing the removal procedure.

RBA Non-Disconnect: Removal or replacement of an RBA fuse unit using a non-disconnect mounting is only performed after it has been de-energized and properly grounded in accordance with good electrical safety practices and all applicable local procedures.

If the mounting uses tension type mounting clips to hold the fuse unit, pull the fuse unit firmly from the clips for removal. Reverse the procedure to mount a new fuse.

When the mounting uses bolted connections to hold the fuse unit, unbolt the mounting hardware and carefully lift the fuse from its mounting. Reverse the procedure to mount a new fuse.

Refill Replacement

Cutler-Hammer RBA Power Fuses utilize a replaceable design. After the fuse holder has been removed from the circuit, the fuse can be recharged by replacement with a new refill unit.

To refill a fuse:

1. Loosen the cap nut with a wrench and remove it from the top of the fuse holder.



2. Unscrew the discharge filter or condenser from the bottom of the fuse holder.



3. Remove the spring and shunt assembly. Unscrew and remove the used fuse refill.



4. Remove the thin plastic disc from the bottom of the new fuse refill unit. Screw the refill into the bottom of the spring and shunt assembly, and hand tighten. Do not use any type of tool to tighten the refill. Screw the refill tool into top of spring and shunt assembly then slide the complete unit into the fuse holder.



5. Grasp the refill tool and pull upward to stretch the spring. Turn the assembly to the right or left to align the pin at the top of the shunt assembly with the slot provided at the tip of the fuse holder. Remove the tool and screw the cap nut on then tighten with a wrench.



6. Screw the discharge filter or condenser into the coupler on the bottom of the fuse holder until it is tight against the fuse refill.



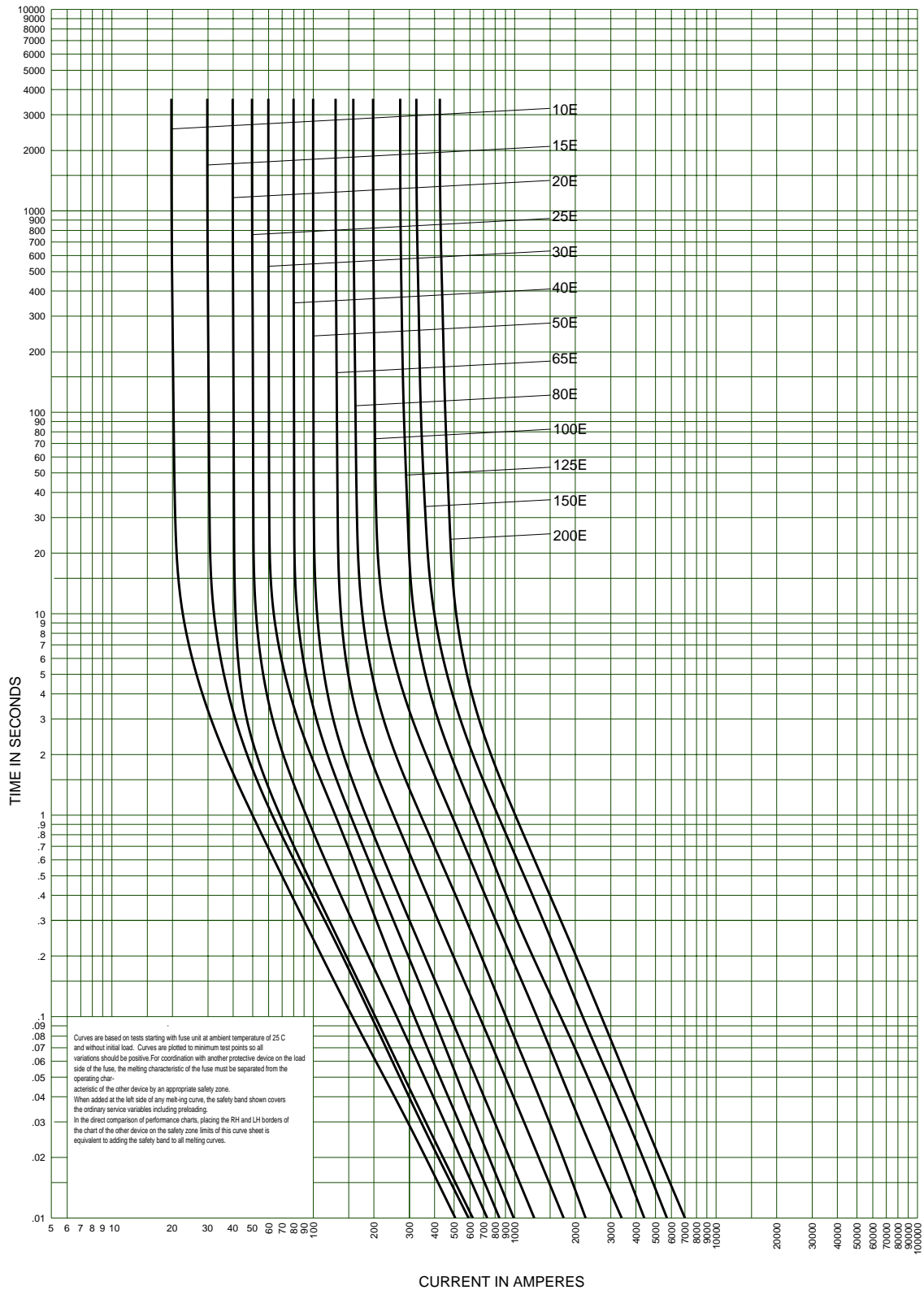

Type RBA-RDB-200 Refill Power Fuses - Standard Speed Refills
Minimum Melting Time-Current Characteristics - 2.4 to 34.5 kV

CURVE 36-635 # 1
April 1999
Reference # 628823

Curves are based on tests starting with fuse unit at ambient temperature of 25°C and without initial load. Curves are plotted to minimum test points so all variations should be positive.

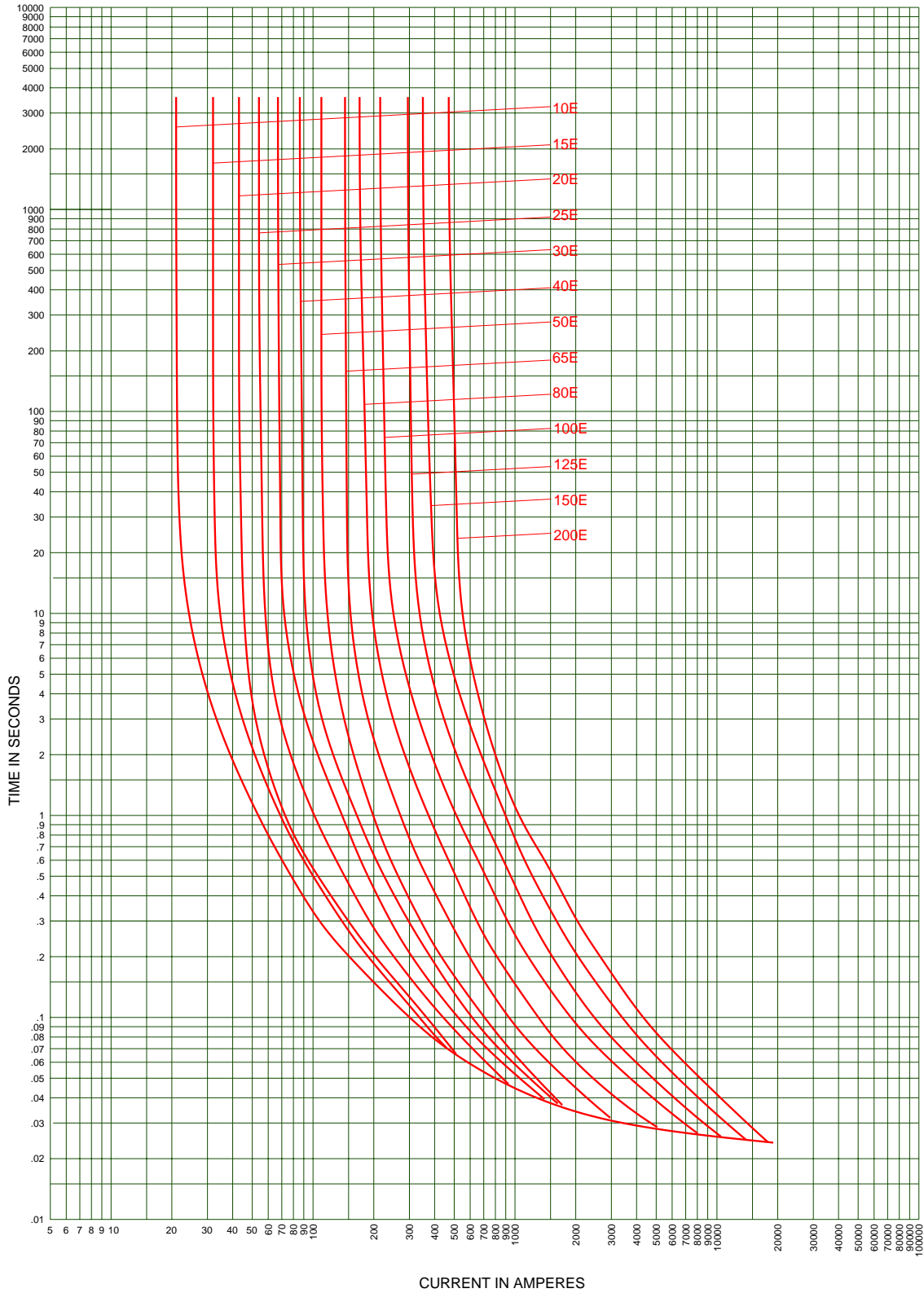

Type RBA-RDB-200 Refill Power Fuses - Standard Speed Refills
Total Clearing Time-Current Characteristics - 2.4 to 34.5 kV

CURVE 36-635 # 2
April 1999
Reference # 667014

Curves are based on tests starting with fuse unit at ambient temperature of 25 C and without initial load.
Curves are plotted to maximum test points so all variations should be negative.

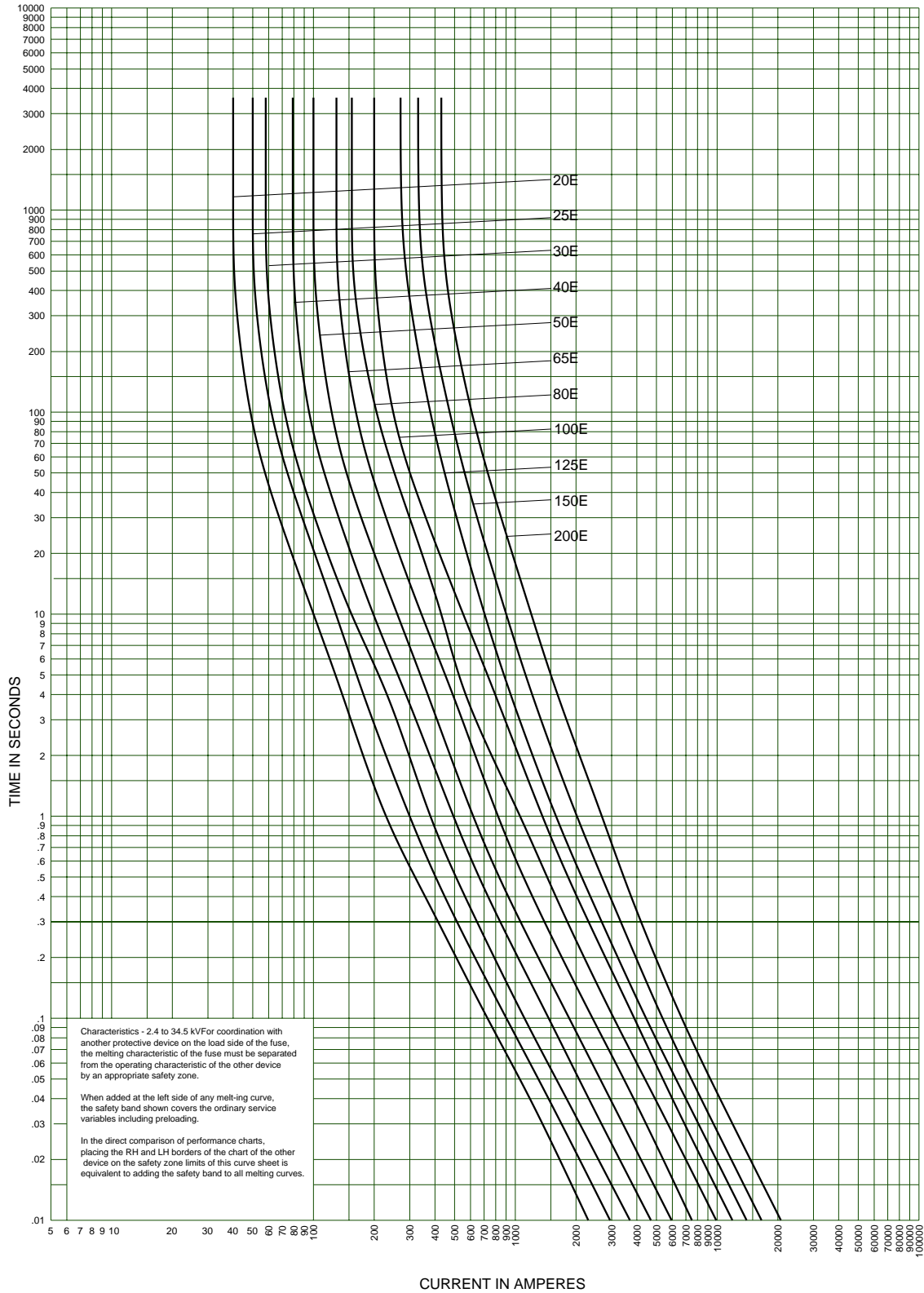

Type RBA-RDB-200 Refill Power Fuses - Time Lag Refills
Minimum Melting Time-Current Characteristics - 2.4 to 34.5 kV

CURVE 36-635 # 3
April 1999
Reference # 628863

Curves are based on tests starting with fuse unit at ambient temperature of 25°C and without initial load.
Curves are plotted to minimum test points so all variations should be positive.

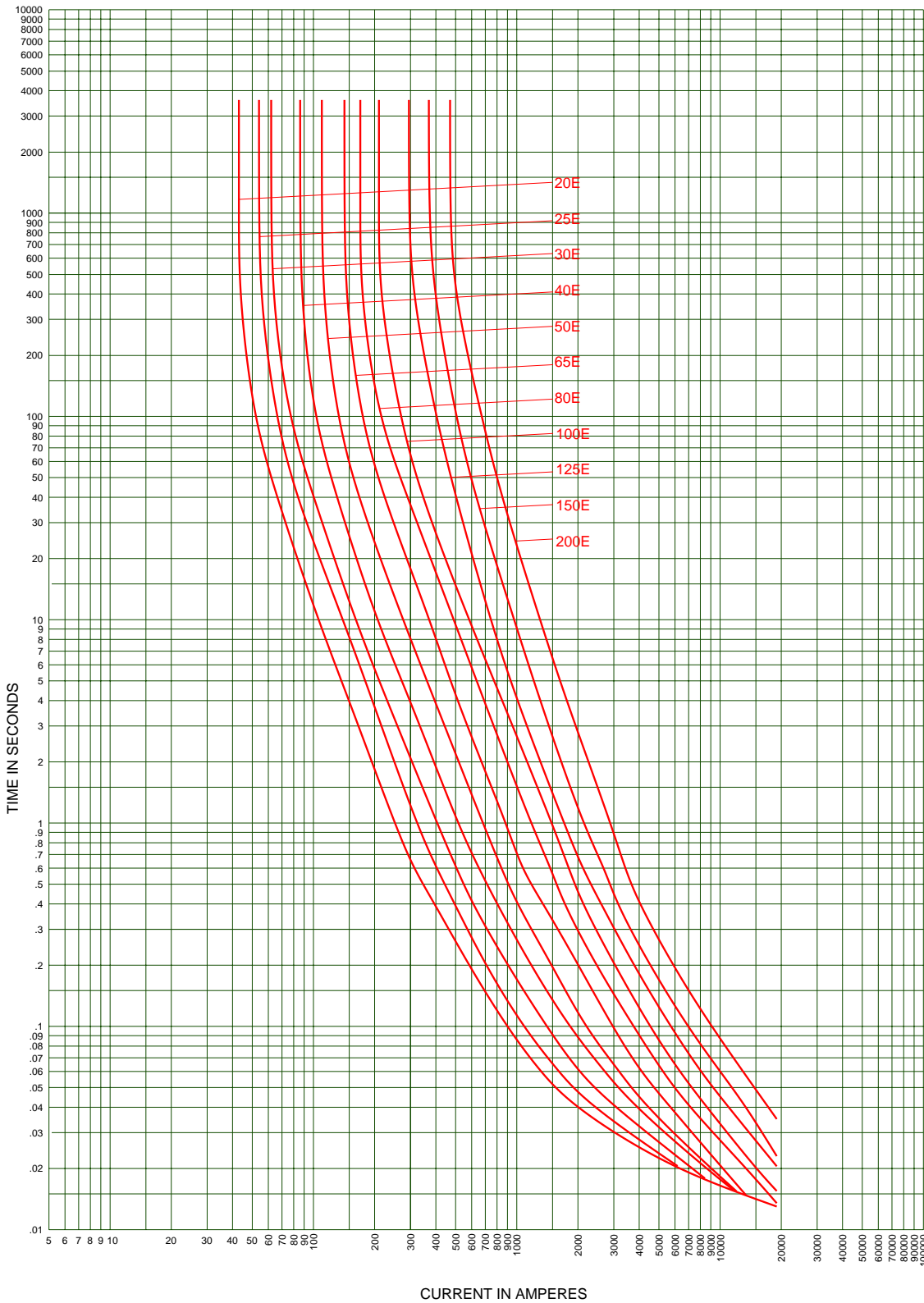

Type RBA-RDB-200 Refill Power Fuses - Time Lag Refills
Total Clearing Time-Current Characteristics - 2.4 to 34.5 kV

CURVE 36-635 # 4
April 1999
Reference # 667013

Curves are based on tests starting with fuse unit at ambient temperature of 25 C and without initial load.
Curves are plotted to maximum test points so all variations should be negative.

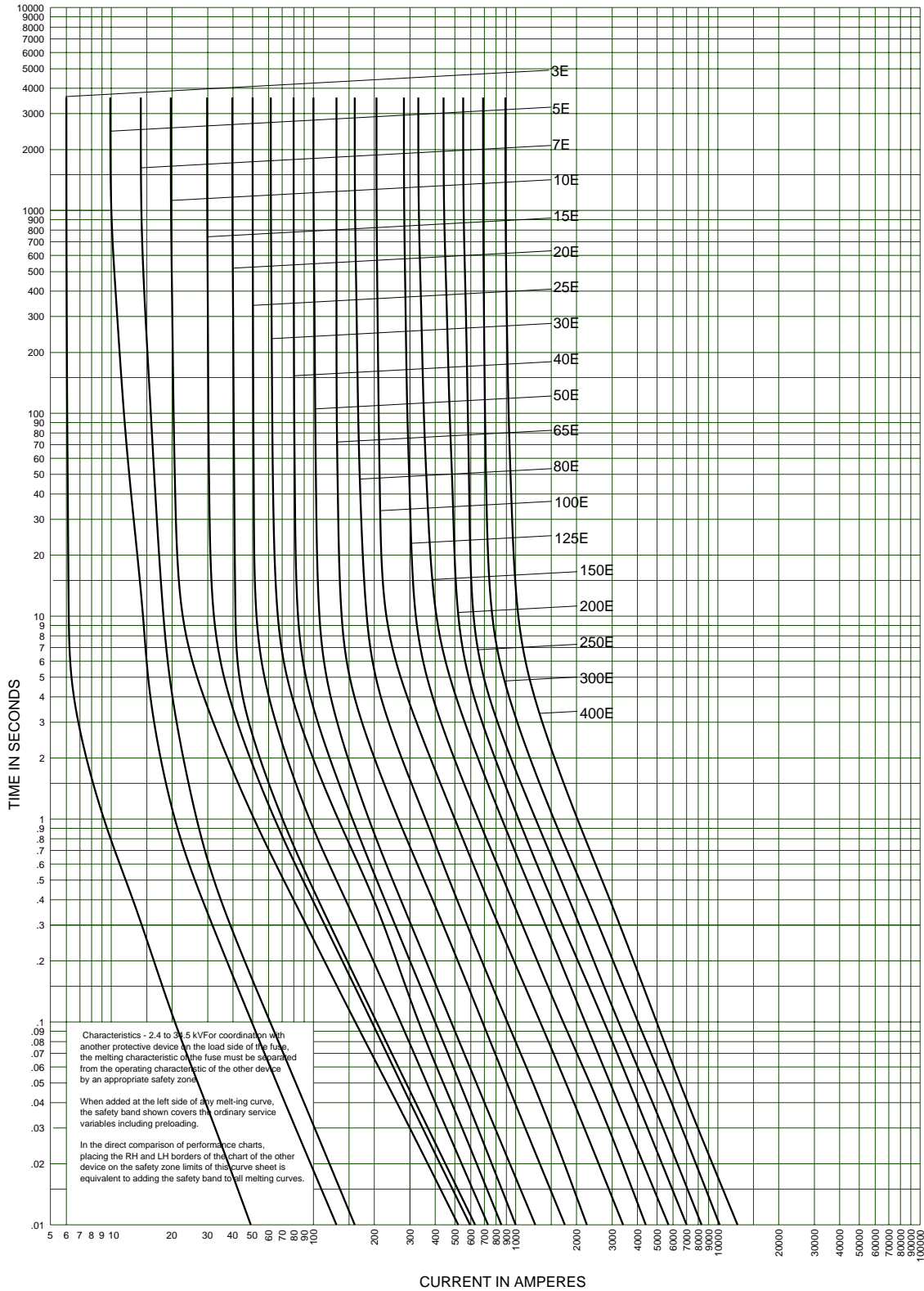

Type RBA-RDB-400 Refill Power Fuses - Standard Speed Refills
Minimum Melting Time-Current Characteristics - 2.4 to 34.5 kV

CURVE 36-635 # 5
April 1999
Reference # 628861

Curves are based on tests starting with fuse unit at ambient temperature of 25°C and without initial load. Curves are plotted to minimum test points so all variations should be positive.

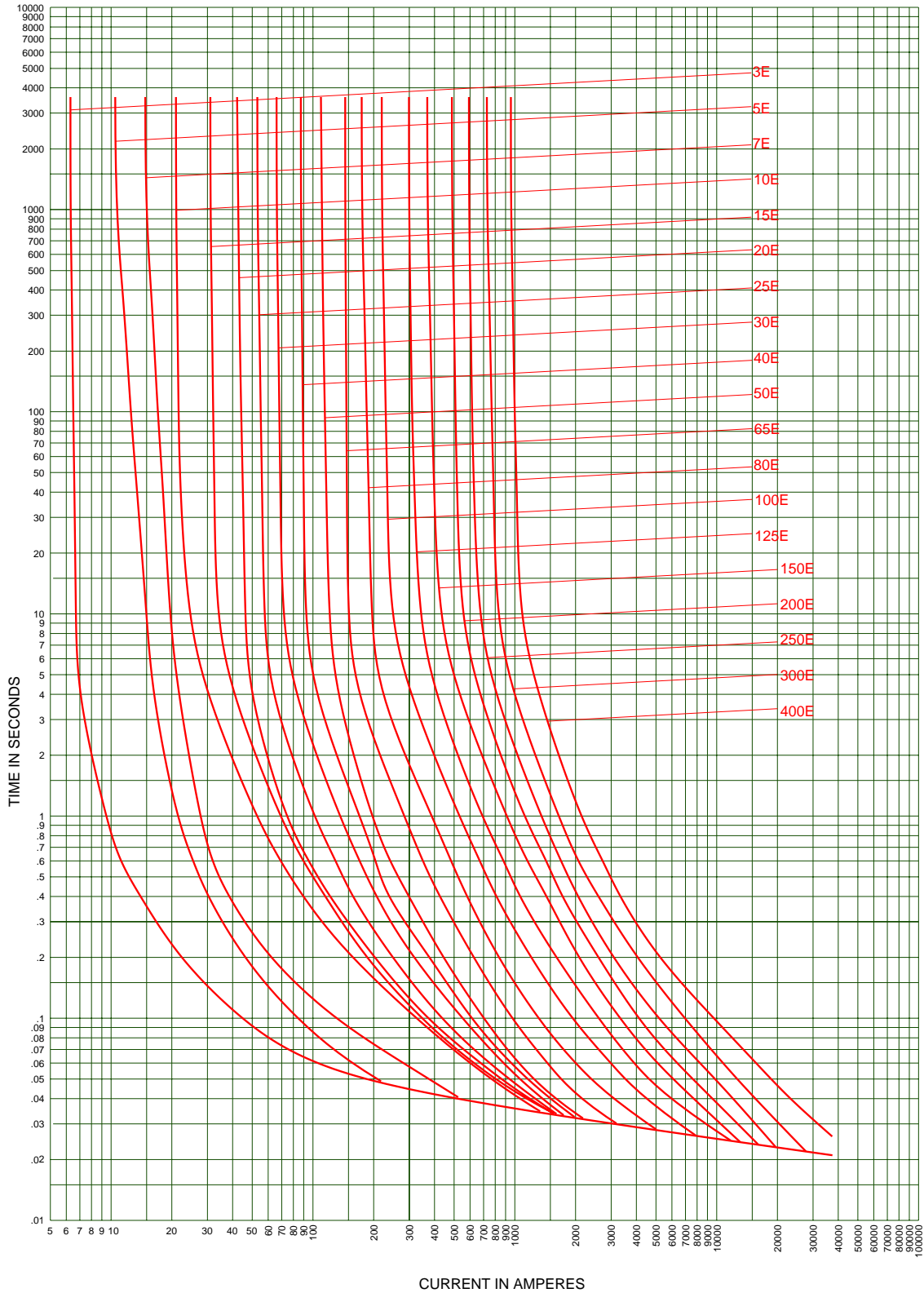

Type RBA-RDB-400 Refill Power Fuses - Standard Speed Refills
Total Clearing Time-Current Characteristics - 2.4 to 34.5 kV

CURVE 36-635 # 6
April 1999
Reference # 667015

Curves are based on tests starting with fuse unit at ambient temperature of 25°C and without initial load.
Curves are plotted to maximum test points so all variations should be negative.

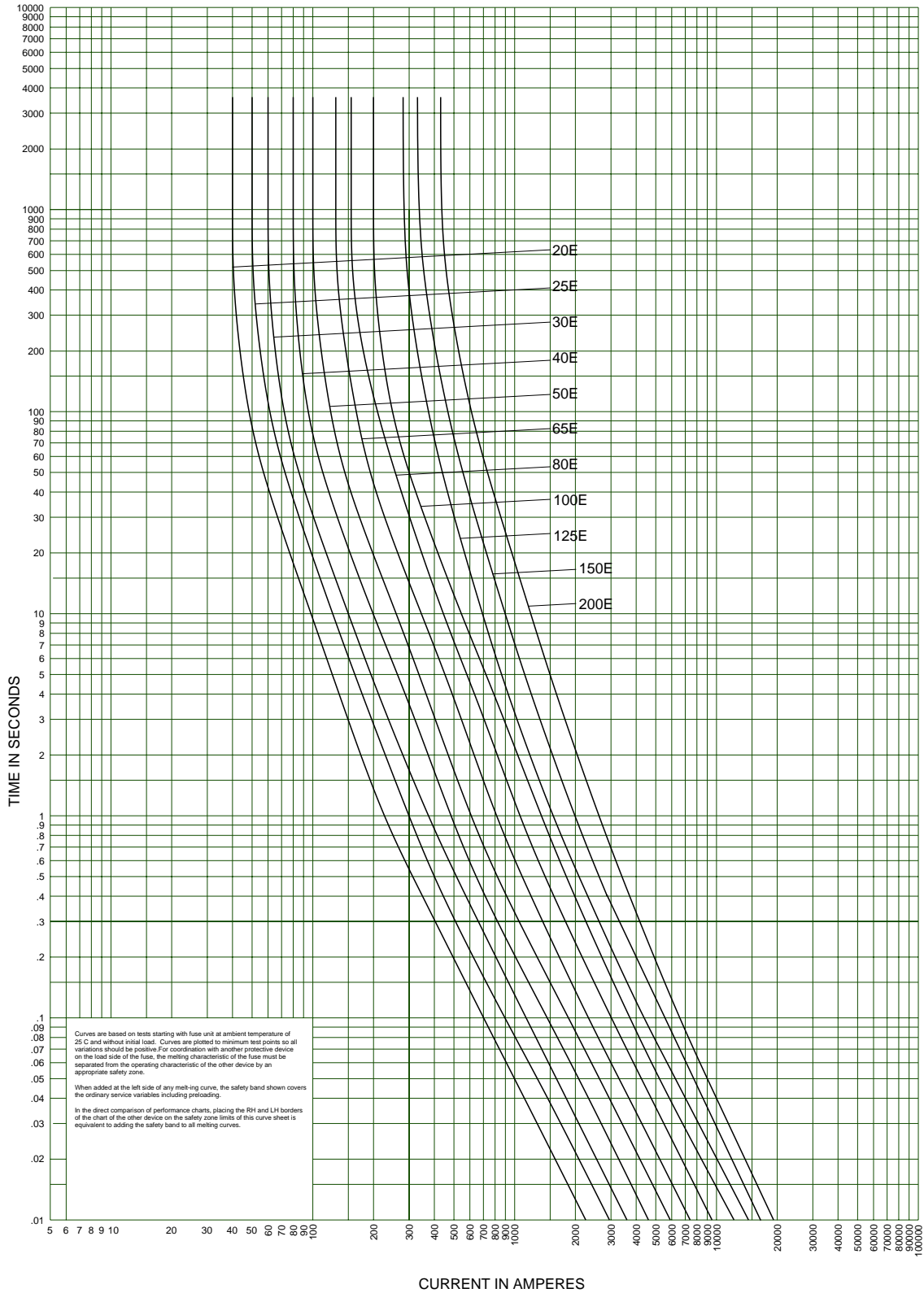

Type RBA-RDB-400 Refill Power Fuses - Time Lag Refills
Minimum Melting Time-Current Characteristics - 2.4 to 34.5 kV

CURVE 36-635 # 7
April 1999
Reference # 628865

Curves are based on tests starting with fuse unit at ambient temperature of 25°C and without initial load.
Curves are plotted to minimum test points so all variations should be positive.

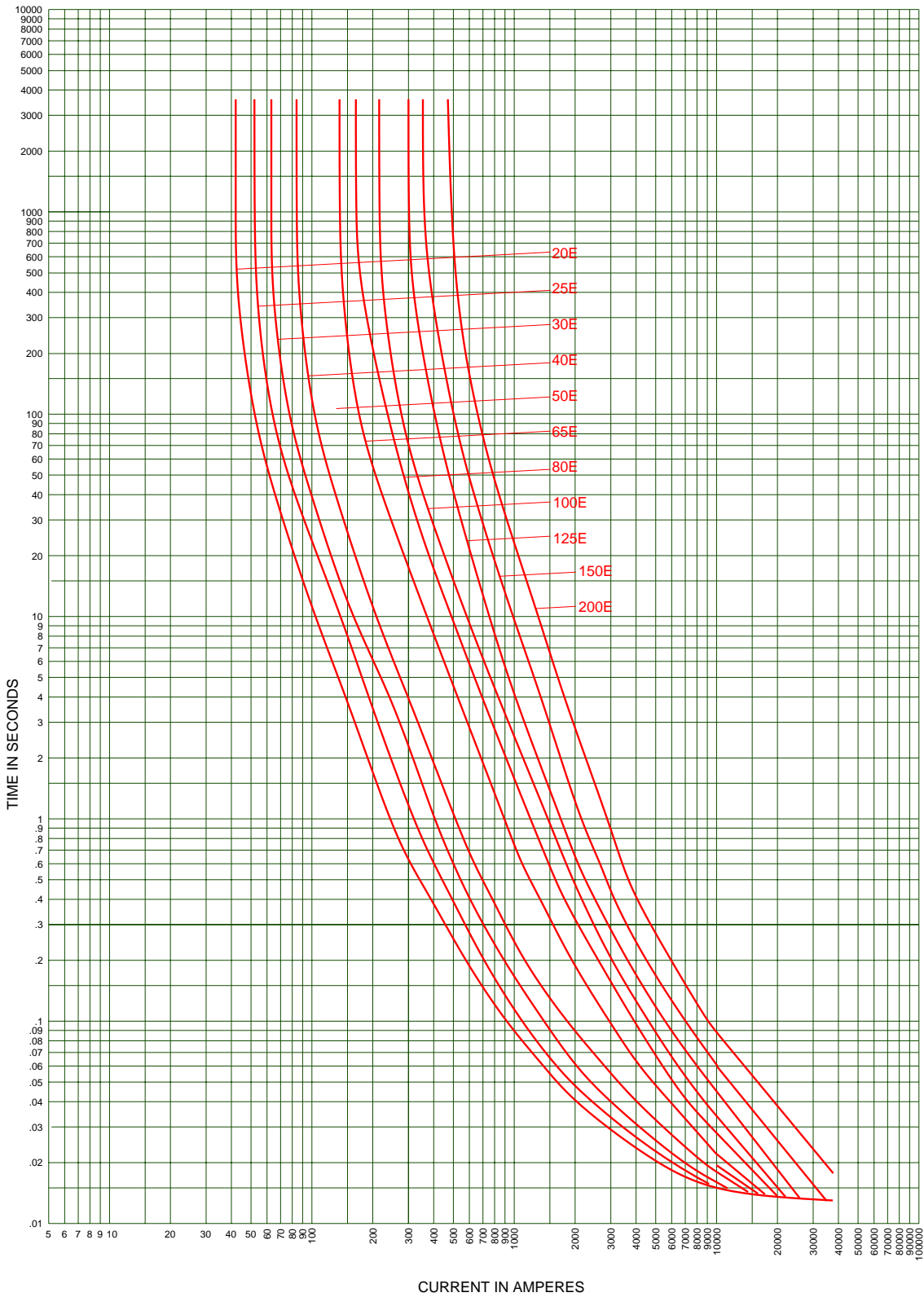

Type RBA-RDB-400 Refill Power Fuses - Time Lag Refills
Total Clearing Time-Current Characteristics - 2.4 to 34.5 kV

CURVE 36-635 # 8
April 1999
Reference # 667012

Curves are based on tests starting with fuse unit at ambient temperature of 25°C and without initial load.
Curves are plotted to maximum test points so all variations should be negative.

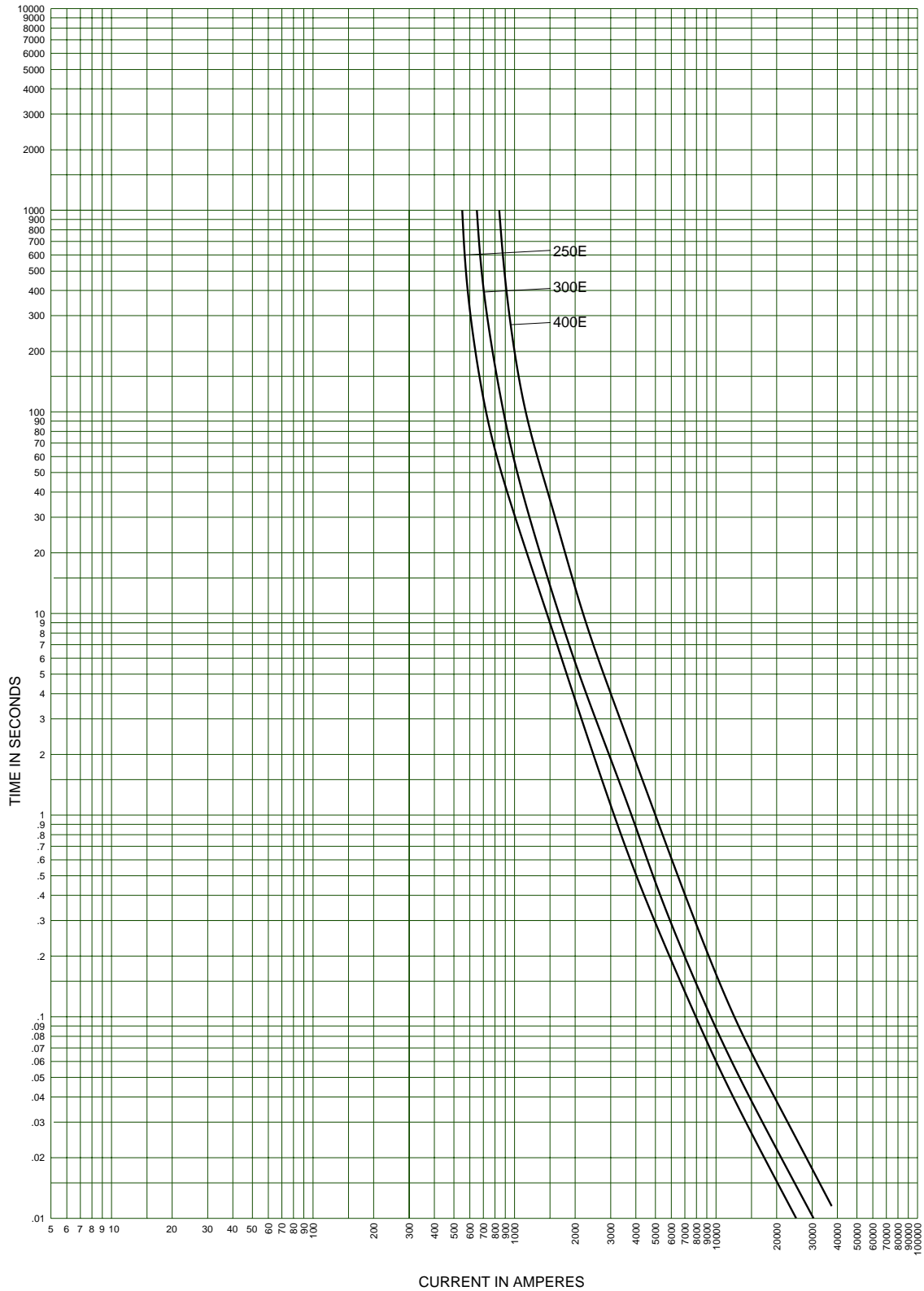

Type RBA-RDB-400 Refill Power Fuses - Time Lag Refills
Minimum Melting Time-Current Characteristics - 2.4 to 34.5 kV

CURVE 36-635 # 9
April 1999
Reference # 639435

Curves are based on tests starting with fuse unit at ambient temperature of 25°C and without initial load.
Curves are plotted to minimum test points so all variations should be positive.

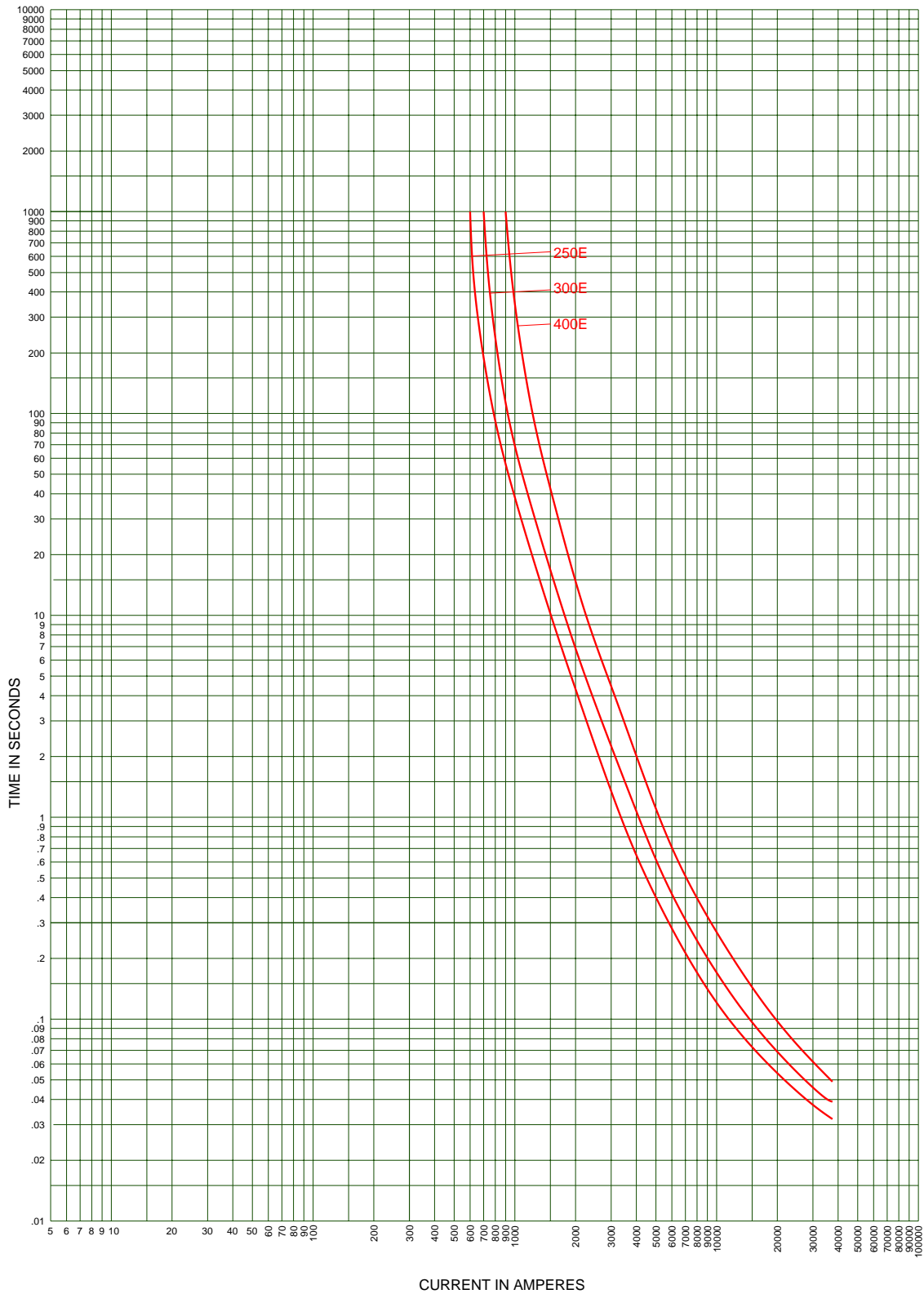

Type RBA-RDB-400 Refill Power Fuses - Time Lag Refills
Total Clearing Time-Current Characteristics - 2.4 to 34.5 kV

CURVE 36-635 # 10
April 1999
Reference # 667011

Curves are based on tests starting with fuse unit at ambient temperature of 25°C and without initial load.
Curves are plotted to maximum test points so all variations should be negative.

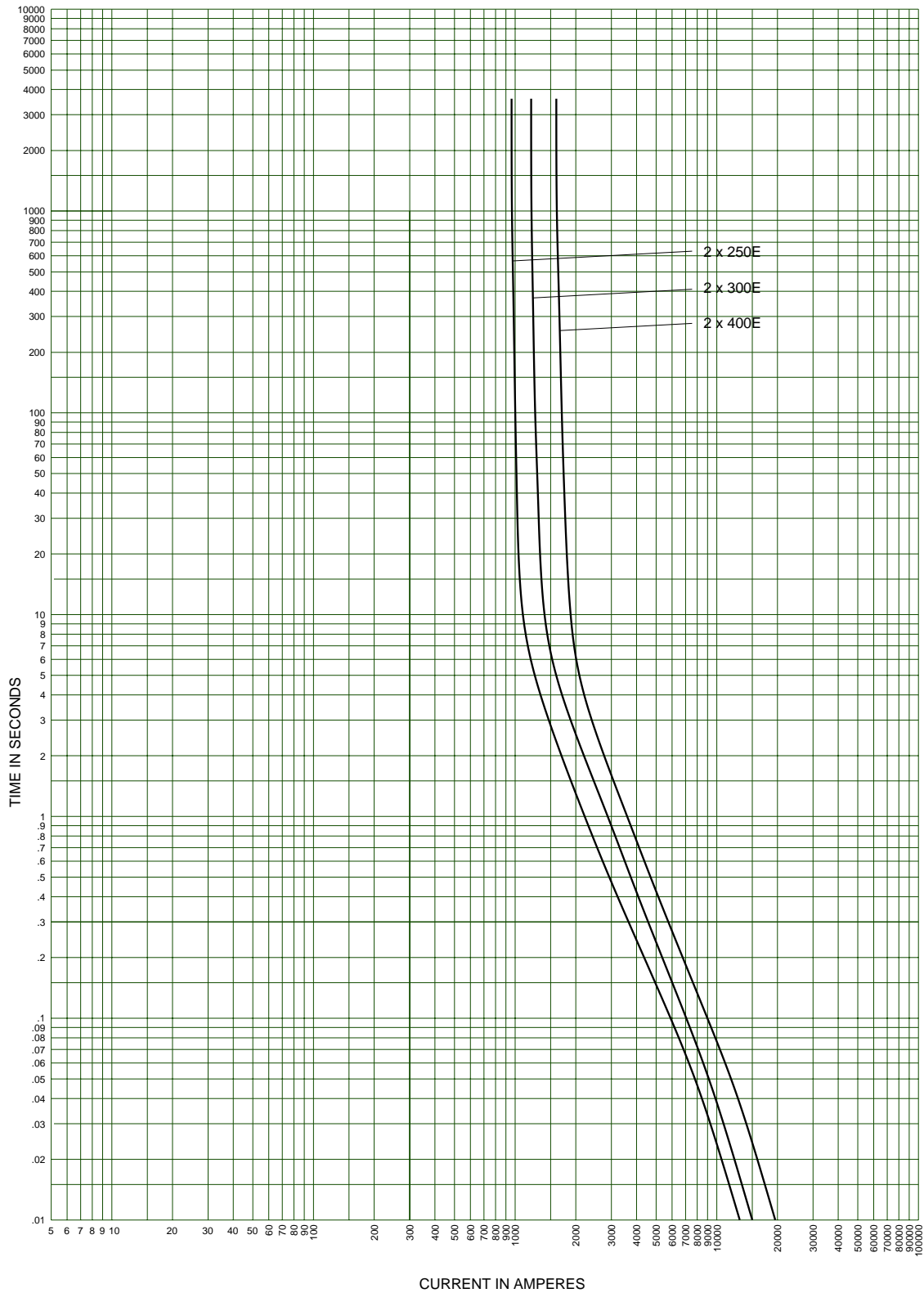

Type RBA-RDB-800 Refill Power Fuses - Standard Speed Refills
Minimum Melting Time-Current Characteristics - 2.4 to 34.5 kV

CURVE 36-635 # 11
April 1999
Reference # 628861

Curves are based on tests starting with fuse unit at ambient temperature of 25°C and without initial load.
Curves are plotted to minimum test points so all variations should be positive.

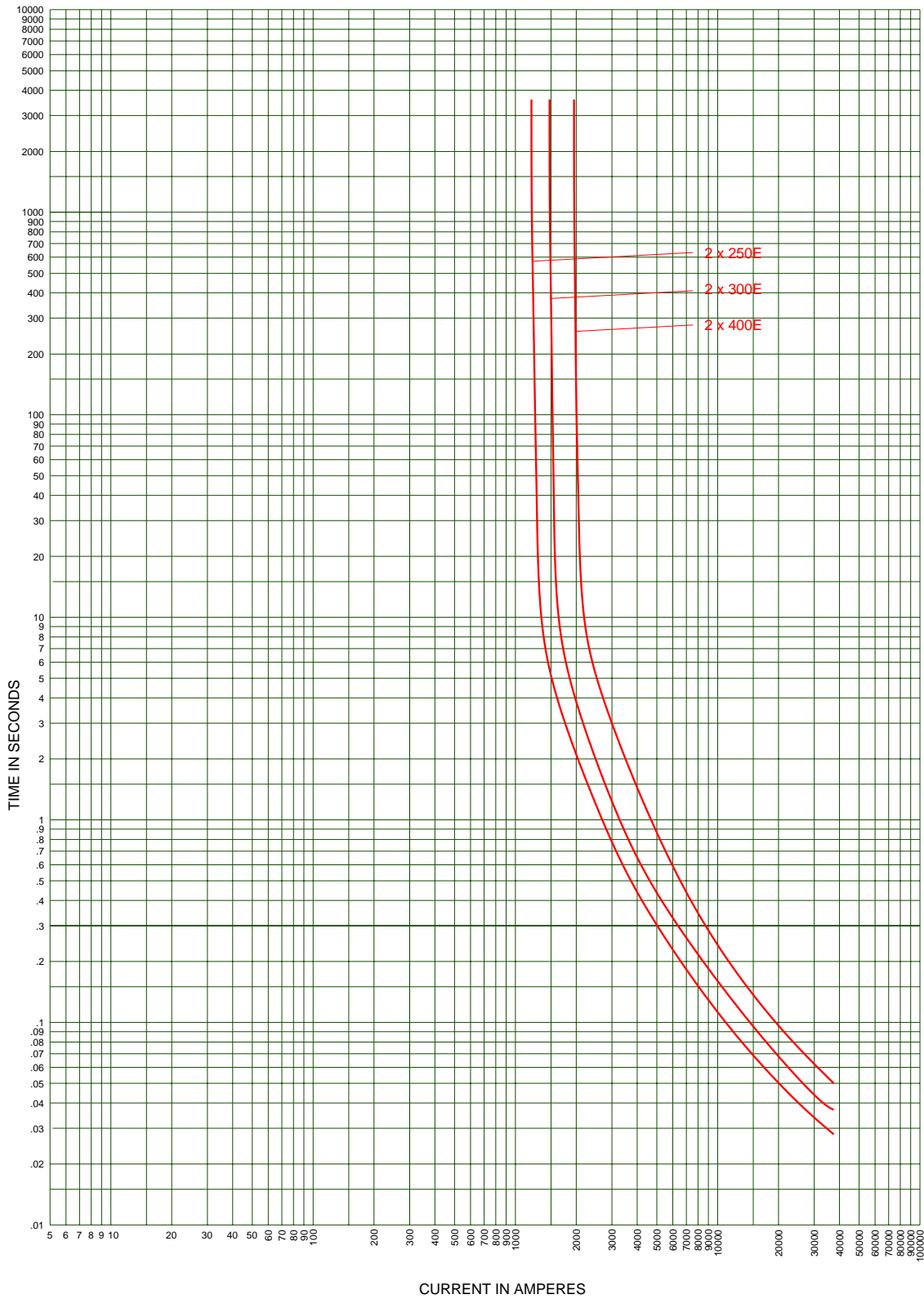

Type RBA-RDB-800 Refill Power Fuses - Standard Speed Refills
Total Clearing Time-Current Characteristics - 2.4 to 34.5 kV

CURVE 36-635 # 12
April 1999
Reference # 667010

Curves are based on tests starting with fuse unit at ambient temperature of 25°C and without initial load.
Curves are plotted to maximum test points so all variations should be negative.

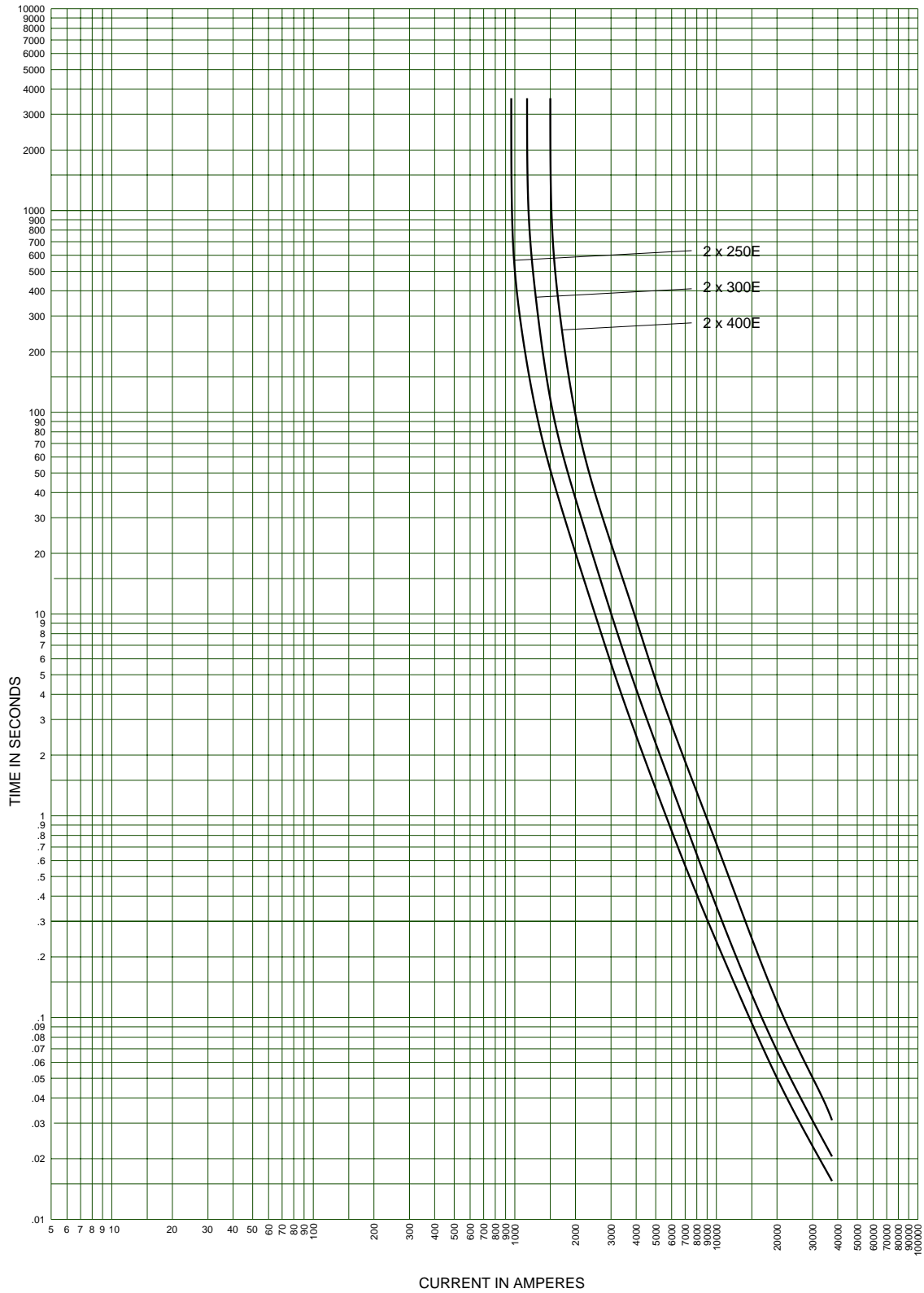

Type RBA-RDB-800 Refill Power Fuses - Time Lag Refills
Minimum Melting Time-Current Characteristics - 2.4 to 34.5 kV

CURVE 36-635 # 13
April 1999
Reference # 639435

Curves are based on tests starting with fuse unit at ambient temperature of 25°C and without initial load.
Curves are plotted to minimum test points so all variations should be positive.

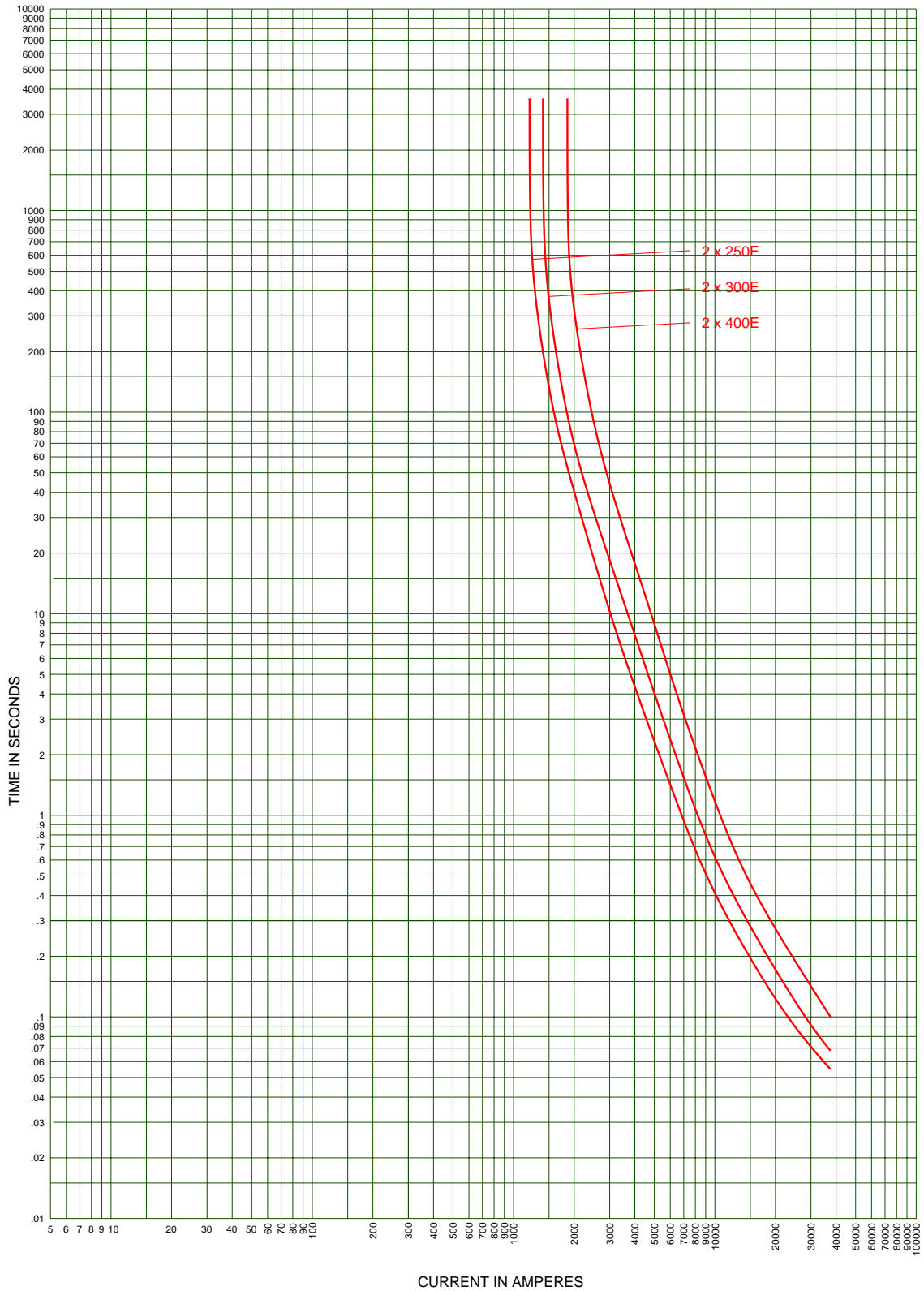



Type RBA-RDB-800 Refill Power Fuses - Time Lag Refills
Total Clearing Time-Current Characteristics - 2.4 to 34.5 kV

CURVE 36-635 # 14
April 1999
Reference # 667009

Curves are based on tests starting with fuse unit at ambient temperature of 25°C and without initial load.
Curves are plotted to maximum test points so all variations should be negative.

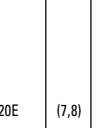
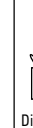
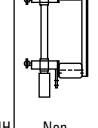
Type RBA Expulsion Fuses for Use Indoors or in an Enclosure

Ampere Rating	Standard Speed (Fuse Refills)		Time-Lag (Fuse Refills)		Approx. Shipping Wt.	Ampere Rating	Fuseholder			Fuse Mounting Style	Voltage (kV)			Mounting (including Live Parts less Holder)		Live Parts	Fuse Filters and Condensers	Spring and Shunt Assembly													
	Catalog Number	Curve Reference 36-635	Catalog Number	Curve Reference 36-635			Style	Non-Indicating	Indicating		Nominal	Max	BIL	Porcelain Insulator	Glass Polyester																
								Catalog Number	Catalog Number					Catalog Number	Catalog Number																
RBA/RBT Refill Units						RBA Fuseholders, Mountings and Hardware (For Use with RBA/RBT Refills)																									
8.3 kV Max (7.2 kV Nominal) 200 Amp						8.3 kV Max (7.2 kV Nominal) 200 Amp																									
10E	8RBA2-10E					10E to 200E		8RBA2-NH	8RBA2-INH		Non Disconnect	4.8 7.2	5.5 8.3	60 75	5RBA2-PNM	5RBA2-GNM	15RBA2-NL	RBA2-FLTR RBA2-COND	8RBA2-SHNT												
15E	8RBA2-15E																														
20E	8RBA2-20E		8RBT2-20E																												
25E	8RBA2-25E		8RBT2-25E																												
30E	8RBA2-30E		8RBT2-30E																												
40E	8RBA2-40E		8RBT2-40E																												
50E	8RBA2-50E	(1,2)	8RBT2-50E	(3,4)	1.0																										
65E	8RBA2-65E		8RBT2-65E																												
80E	8RBA2-80E		8RBT2-80E																												
100E	8RBA2-100E		8RBT2-100E																												
125E	8RBA2-125E		8RBT2-125E																												
150E	8RBA2-150E		8RBT2-150E																												
200E	8RBA2-200E		8RBT2-200E																												
8.3 kV Max (7.2 kV Nominal) 400 Amp						8.3 kV Max (7.2 kV Nominal) 400 Amp																									
.5E	8RBA4-.5E					.5E to 400E		8RBA4-NH	8RBA4-INH		Non Disconnect	4.8 7.2	5.5 8.3	60 75	5RBA4-PNM	5RBA4-GNM	15RBA4-NL	RBA4-FLTR RBA4-COND	8RBA4-SHNT												
3E	8RBA4-3E																														
5E	8RBA4-5E																														
7E	8RBA4-7E																														
10E	8RBA4-10E																														
15E	8RBA4-15E																														
20E	8RBA4-20E		8RBT4-20E	(7,8)																											
25E	8RBA4-25E		8RBT4-25E	(7,8)																											
30E	8RBA4-30E		8RBT4-30E	(7,8)																											
40E	8RBA4-40E		8RBT4-40E	(7,8)																											
50E	8RBA4-50E	(5,6)	8RBT4-50E	(7,8)	2.1																										
65E	8RBA4-65E		8RBT4-65E	(7,8)																											
80E	8RBA4-80E		8RBT4-80E	(7,8)																											
100E	8RBA4-100E		8RBT4-100E	(7,8)																											
125E	8RBA4-125E		8RBT4-125E	(7,8)																											
150E	8RBA4-150E		8RBT4-150E	(7,8)																											
200E	8RBA4-200E		8RBT4-200E	(7,8)																											
250E	8RBA4-250E		8RBT4-250E	(10,11)																											
300E	8RBA4-300E		8RBT4-300E	(10,11)																											
400E	8RBA4-400E		8RBT4-400E	(10,11)																											
8.3 kV Max (7.2 kV Nominal) 800 Amp						8.3 kV Max (7.2 kV Nominal) 800 Amp																									
450E	(2)8RBA4-250E		(2)8RBT4-250E		⓪	450E		8RBA8-NH	8RBA8-INH	Non Disconnect	4.8 7.2	5.5 8.3	60 75	5RBA8-PNM	5RBA8-GNM	15RBA8-NL	(2)RBA4-FLTR⓪ (2)RBA4-COND⓪	8RBA4SHNT													
540E	(2)8RBA4-300E	(9)	(2)8RBT4-300E	(12)	⓪																										
720E	(2)8RBA4-400E		(2)8RBT4-400E		⓪																										

⓪ Requires two fuse refills as shown. Price each refill individually. Example: To order refill units for a 720E, 8.3kV fuse, order 2 pieces of an 8RBA4-400E.
 ⓪ Two filters or condensers required.

For new installation: Order one refill (Standard Speed or Time Lag), one fuseholder, one mounting, and one filter or condenser per phase. Live parts can be substituted for the mounting if user is supplying base support and insulators.

Type RBA Expulsion Fuses for Use Indoors or in an Enclosure

Ampere Rating	Standard Speed (Fuse Refills)		Time-Lag (Fuse Refills)		Approx. Shipping Wt.	Ampere Rating	Fuseholder			Fuse Mounting Style	Voltage (kV)			Mounting (including Live Parts less Holder)		Live Parts	Fuse Filters and Condensers	Spring and Shunt Assembly					
	Catalog Number	Curve Reference 36-635	Catalog Number	Curve Reference 36-635			Style	Non-Indicating	Indicating		Nominal	Max	BIL	Porcelain Insulator	Glass Polyester								
								Catalog Number	Catalog Number					Catalog Number	Catalog Number								
RBA/RBT Refill Units						RBA Fuseholders, Mountings and Hardware (For Use with RBA/RBT Refills)																	
15.5 kV Max (14.4 kV Nominal) 200 Amp						15.5 kV Max (14.4 kV Nominal) 200 Amp																	
10E	15RBA2-10E	(1,2)				10E		15RBA2-NH	15RBA2-INH		13.8	15.5	95	14RBA2-PNM	14RBA2-GNM	15RBA2-NL							
15E	15RBA2-15E	(1,2)									13.8	15.5	110	15RBA2-PNM									
20E	15RBA2-20E	(1,2)	15RBT2-20E	(3,4)							Non Disconnect			Non Disconnect									
25E	15RBA2-25E	(1,2)	15RBT2-25E	(3,4)																			
30E	15RBA2-30E	(1,2)	15RBT2-30E	(3,4)																			
40E	15RBA2-40E	(1,2)	15RBT2-40E	(3,4)																			
50E	15RBA2-50E	(1,2)	15RBT2-50E	(3,4)	1.1																		
65E	15RBA2-65E	(1,2)	15RBT2-65E	(3,4)																			
80E	15RBA2-80E	(1,2)	15RBT2-80E	(3,4)																			
100E	15RBA2-100E	(1,2)	15RBT2-100E	(3,4)							200E		15RBA2-DH		3.8	15.5	95	14RBA2-PDM	14RBA2-GDM	38RBA2-DL			
125E	15RBA2-125E	(1,2)	15RBT2-125E	(3,4)		13.8	15.5	110	15RBA2-PDM														
150E	15RBA2-150E	(1,2)	15RBT2-150E	(3,4)																			
200E	15RBA2-200E	(1,2)	15RBT2-200E	(3,4)		Disconnect			Disconnect														
15.5 kV Max (14.4 kV Nominal) 400 Amp						15.5 kV Max (14.4 kV Nominal) 400 Amp																	
.5E	15RBA4-.5E	(5,6)				.5E to 400E		15RBA4-NH	15RBA4-INH		13.8	15.5	95	14RBA4-PNM	14RBA4-GNM	15RBA4-NL							
3E	15RBA4-3E	(5,6)									13.8	15.5	110	15RBA4-PNM									
5E	15RBA4-5E	(5,6)									Non Disconnect			Non Disconnect									
7E	15RBA4-7E	(5,6)																					
10E	15RBA4-10E	(5,6)																					
15E	15RBA4-15E	(5,6)																					
20E	15RBA4-20E	(5,6)	15RBT4-20E	(7,8)																			
25E	15RBA4-25E	(5,6)	15RBT4-25E	(7,8)																			
30E	15RBA4-30E	(5,6)	15RBT4-30E	(7,8)																			
40E	15RBA4-40E	(5,6)	15RBT4-40E	(7,8)																			
50E	15RBA4-50E	(5,6)	15RBT4-50E	(7,8)	2.3																		
65E	15RBA4-65E	(5,6)	15RBT4-65E	(7,8)																			
80E	15RBA4-80E	(5,6)	15RBT4-80E	(7,8)																			
100E	15RBA4-100E	(5,6)	15RBT4-100E	(7,8)		400E		15RBA4-DH		13.8	15.5	95	14RBA4-PDM	14RBA4-GDM	15RBA4-DL								
125E	15RBA4-125E	(5,6)	15RBT4-125E	(7,8)						13.8	15.5	110	15RBA4-PDM										
150E	15RBA4-150E	(5,6)	15RBT4-150E	(7,8)																			
200E	15RBA4-200E	(5,6)	15RBT4-200E	(7,8)																			
250E	15RBA4-250E	(5,6)	15RBT4-250E	(10,11)																			
300E	15RBA4-300E	(5,6)	15RBT4-300E	(10,11)																			
400E	15RBA4-400E	(5,6)	15RBT4-400E	(10,11)						Disconnect			Disconnect										
15.5 kV Max (14.4 kV Nominal) 800 Amp										15.5 kV Max (14.4 kV Nominal) 800 Amp													
450E	(2)15RBA4-250E	(9)	(2)15RBT4-250E	(12)	Ⓢ					450E		15RBA8-NH	15RBA8-INH		13.8	15.5	95	14RBA8-PNM	14RBA8-GNM	15RBA8-NL	(2)RBA4-FLTR [Ⓢ]	15RBA4-SHNT	
540E	(2)15RBA4-300E	(9)	(2)15RBT4-300E	(12)	Ⓢ					13.8					15.5	110	15RBA8-PNM						
720E	(2)15RBA4-400E	(9)	(2)15RBT4-400E	(12)	Ⓢ	13.8	15.5	110	15RBA8-PNM											(2)RBA4-COND [Ⓢ]			

Ⓢ Requires two fuse refills as shown. Price each refill individually. Example: To order refill units for a 720E, 15 kV fuse, order 2 pieces of an 15RBA4-400E.
 Ⓢ Two filters or condensers required.

For new installation: Order one refill (Standard Speed or Time Lag), one fuseholder, one mounting, and one filter or condenser per phase. Live parts can be substituted for the mounting if user is supplying base support and insulators.

Type RBA Expulsion Fuses for Use Indoors or in an Enclosure

Ampere Rating	Standard Speed (Fuse Refills)		Time-Lag (Fuse Refills)		Approx. Shipping Wt.	Ampere Rating	Fuseholder			Fuse Mounting Style	Voltage (kV)			Mounting (including Live Parts less Holder)		Live Parts	Fuse Filters and Condensers	Spring and Shunt Assembly										
	Catalog Number	Curve Reference 36-635	Catalog Number	Curve Reference 36-635			Style	Non-Indicating	Indicating		Nominal	Max	BIL	Porcelain Insulator	Glass Polyester				Catalog Number	Catalog Number								
																					Catalog Number	Catalog Number	Catalog Number	Catalog Number	Catalog Number			
RBA/RBT Refill Units						RBA Fuseholders, Mountings and Hardware (For Use with RBA/RBT Refills)																						
25.5 kV Max (23.0 kV Nominal) 200Amp						25.5 kV Max (23.0 kV Nominal) 200 Amp																						
10E	25RBA2-10E					10E to 200E		25RBA2-NH	25RBA2-INH		23.0	25.5	150	25RBA2-PNM	38RBA2-NL	RBA2-FLTR RBA2-COND	25RBA2-SHNT											
15E	25RBA2-15E				Non													Disconnect	Non	Disconnect								
20E	25RBA2-20E		25RBT2-20E																									
25E	25RBA2-25E		25RBT2-25E																									
30E	25RBA2-30E		25RBT2-30E																									
40E	25RBA2-40E		25RBT2-40E																									
50E	25RBA2-50E	(1,2)	25RBT2-50E	(3,4)	1.3																							
65E	25RBA2-65E		25RBT2-65E																									
80E	25RBA2-80E		25RBT2-80E																									
100E	25RBA2-100E		25RBT2-100E																									
125E	25RBA2-125E		25RBT2-125E																									
150E	25RBA2-150E		25RBT2-150E																									
200E	25RBA2-200E		25RBT2-200E																									
25.5 kV Max (23.0 kV Nominal) 400 Amp						25.5 kV Max (23.0 kV Nominal) 400 Amp																						
.5E	25RBA4-.5E					.5E to 300E		25RBA4-NH	25RBA4-INH		23.0	25.5	150	25RBA4-PNM	38RBA4-NL	RBA4-FLTR RBA4-COND	25RBA4-SHNT											
3E	25RBA4-3E				Non													Disconnect	Non	Disconnect								
5E	25RBA4-5E																											
7E	25RBA4-7E																											
10E	25RBA4-10E																											
15E	25RBA4-15E																											
20E	25RBA4-20E		25RBT4-20E	(7,8)																								
25E	25RBA4-25E		25RBT4-25E	(7,8)																								
30E	25RBA4-30E		25RBT4-30E	(7,8)																								
40E	25RBA4-40E		25RBT4-40E	(7,8)																								
50E	25RBA4-50E	(5,6)	25RBT4-50E	(7,8)	2.7																							
65E	25RBA4-65E		25RBT4-65E	(7,8)																								
80E	25RBA4-80E		25RBT4-80E	(7,8)																								
100E	25RBA4-100E		25RBT4-100E	(7,8)																								
125E	25RBA4-125E		25RBT4-125E	(7,8)																								
150E	25RBA4-150E		25RBT4-150E	(7,8)																								
200E	25RBA4-200E		25RBT4-200E	(7,8)																								
250E	25RBA4-250E		25RBT4-250E	(10,11)																								
300E	25RBA4-300E		25RBT4-300E	(10,11)																								
25.5 kV Max (23.0 kV Nominal) 800 Amp						25.5 kV Max (23.0 kV Nominal) 800 Amp																						
450E	(2)25RBA4-250E	(9)	(2)25RBT4-250E	(12)	Ⓚ	450E to 540E		25RBA8-NH	25RBA8-INH		23.0	25.5	150	25RBA8-PNM	38RBA8-NL	(2)RBA4-FLTRⓀ (2)RBA4-CONDⓀ												
540E	(2)25RBA4-300E	(9)	(2)25RBT4-300E	(12)	Ⓚ												Non	Disconnect	Non	Disconnect								

Ⓚ Requires two fuse refills as shown. Price each refill individually. Example: To order refill units for a 720E, 25 kV fuse, order 2 pieces of an 25RBA4-400E.
 Ⓚ Two filters or condensers required.

For new installation: Order one refill (Standard Speed or Time Lag), one fuseholder, one mounting, and one filter or condenser per phase. Live parts can be substituted for the mounting if user is supplying base support and insulators.





Type RBA Expulsion Fuses for Use Indoors or in an Enclosure

Ampere Rating	Standard Speed (Fuse Refills)		Time-Lag (Fuse Refills)		Approx. Shipping Wt.	Ampere Rating	Fuseholder			Fuse Mounting Style	Voltage (kV)			Mounting (including Live Parts less Holder)		Live Parts	Fuse Filters and Condensers	Spring and Shunt Assembly			
	Catalog Number	Curve Reference 36-635	Catalog Number	Curve Reference 36-635			Style	Non-Indicating	Indicating		Nominal	Max	BIL	Porcelain Insulator	Glass Polyester				Catalog Number	Catalog Number	
																					Catalog Number
RBA/RBT Refill Units						RBA Fuseholders, Mountings and Hardware (For Use with RBA/RBT Refills)															
38.0 kV Max (34.5 kV Nominal) 200Amp						38.0 kV Max (34.5 kV Nominal) 200 Amp															
10E	38RBA2-10E					10E to 200E				Non Disconnect											
15E	38RBA2-15E																				
20E	38RBA2-20E		38RBT2-20E																		
25E	38RBA2-25E		38RBT2-25E																		
30E	38RBA2-30E		38RBT2-30E																		
40E	38RBA2-40E		38RBT2-40E																		
50E	38RBA2-50E	(1,2)	38RBT2-50E	(3,4)	1.4																
65E	38RBA2-65E		38RBT2-65E																		
80E	38RBA2-80E		38RBT2-80E																		
100E	38RBA2-100E		38RBT2-100E																		
125E	38RBA2-125E		38RBT2-125E																		
150E	38RBA2-150E		38RBT2-150E																		
200E	38RBA2-200E		38RBT2-200E																		
38.0 kV Max (34.5 kV Nominal) 400 Amp							38.0 kV Max (34.5 kV Nominal) 400 Amp														
.5E	38RBA4-.5E						.5E to 300E					Non Disconnect									
3E	38RBA4-3E																				
5E	38RBA4-5E																				
7E	38RBA4-7E																				
10E	38RBA4-10E																				
15E	38RBA4-15E																				
20E	38RBA4-20E		38RBT4-20E	(7,8)																	
25E	38RBA4-25E		38RBT4-25E	(7,8)	3.1																
30E	38RBA4-30E	(5,6)	38RBT4-30E	(7,8)																	
40E	38RBA4-40E		38RBT4-40E	(7,8)																	
50E	38RBA4-50E		38RBT4-50E	(7,8)																	
65E	38RBA4-65E		38RBT4-65E	(7,8)																	
80E	38RBA4-80E		38RBT4-80E	(7,8)																	
100E	38RBA4-100E		38RBT4-100E	(7,8)																	
125E	38RBA4-125E		38RBT4-125E	(7,8)																	
150E	38RBA4-150E		38RBT4-150E	(7,8)																	
200E	38RBA4-200E		38RBT4-200E	(7,8)																	
250E	38RBA4-250E		38RBT4-250E	(10,11)																	
300E	38RBA4-300E		38RBT4-300E	(10,11)																	
38.0 kV Max (34.5 kV Nominal) 800 Amp						38.0 kV Max (34.5 kV Nominal) 800 Amp															
450E	(2)38RBA4-250E	(9)	(2)38RBT4-250E	(12)	①	450E to 540E				Non Disconnect											
540E	(2)38RBA4-300E	(9)	(2)38RBT4-300E	(12)	①																

① Requires two fuse refills as shown. Price each refill individually. Example: To order refill units for a 720E, 38 kV fuse, order 2 pieces of an 38RBA4-400E.
 ② Two filters or condensers required.

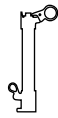
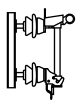
For new installation: Order one refill (Standard Speed or Time Lag), one fuseholder, one mounting, and one filter or condenser per phase. Live parts can be substituted for the mounting if user is supplying base support and insulators.

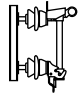

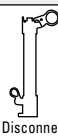

Type RDB Expulsion Fuses for Use Outdoors

Ampere Rating	Standard Speed (Fuse Refills)		Time-Lag (Fuse Refills)		Approx. Shipping Wt.	Ampere Rating	Fuseholder		Voltage (kV)			Mounting (including Live Parts less Holder)		Live Parts		Spring and Shunt Assembly							
	Catalog Number	Curve Reference 36-635	Catalog Number	Curve Reference 36-635			Style	Catalog Number	Nominal	Max	BIL	Vertical (180°) Mounting	Underhung (90°) Mounting	Vertical	Underhung								
												Catalog Number	Catalog Number	Catalog Number	Catalog Number								
RBA/RBT Refill Units						RDB Fuseholders, Mountings and Hardware (For Use with RBA/RBT Refills)																	
8.3 kV Max (17.2 kV Nominal) 200 Amp						8.3 kV Max (17.2 kV Nominal) 200 Amp																	
10E	8RBA2-10E					 Disconnect	8RDB2-DH	7.2	8.3	95			RDB2-VL	RDB2-UL	8RDB2-SHNT								
15E	8RBA2-15E				8RBT2-20E			8RBT2-25E	8RBT2-30E	8RBT2-40E	8RBT2-50E	8RBT2-65E				8RBT2-80E	8RBT2-100E	8RBT2-125E	8RBT2-150E	8RBT2-200E			
20E	8RBA2-20E																						
25E	8RBA2-25E																						
30E	8RBA2-30E																						
40E	8RBA2-40E																						
50E	8RBA2-50E	(1,2)			(3,4)																		
65E	8RBA2-65E																						
80E	8RBA2-80E																						
100E	8RBA2-100E																						
125E	8RBA2-125E																						
150E	8RBA2-150E																						
200E	8RBA2-200E																						
8.3 kV Max (7.2 kV Nominal) 400 Amp								8.3 kV Max (7.2 kV Nominal) 400 Amp															
.5E	8RBA4-.5E					 Disconnect	8RDB4-DH	7.2	8.3	95			RDB4-VL	RDB4-UL	8RDB4-SHNT								
3E	8RBA4-3E				8RBT4-20E			8RBT4-25E	8RBT4-30E	8RBT4-40E	8RBT4-50E	8RBT4-65E				8RBT4-80E	8RBT4-100E	8RBT4-125E	8RBT4-150E	8RBT4-200E	8RBT4-250E	8RBT4-300E	8RBT4-400E
5E	8RBA4-5E																						
7E	8RBA4-7E																						
10E	8RBA4-10E																						
15E	8RBA4-15E																						
20E	8RBA4-20E				(7,8)																		
25E	8RBA4-25E				(7,8)																		
30E	8RBA4-30E				(7,8)																		
40E	8RBA4-40E				(7,8)																		
50E	8RBA4-50E	(5,6)			(7,8)																		
65E	8RBA4-65E				(7,8)																		
80E	8RBA4-80E				(7,8)																		
100E	8RBA4-100E				(7,8)																		
125E	8RBA4-125E				(7,8)																		
150E	8RBA4-150E				(7,8)																		
200E	8RBA4-200E				(7,8)																		
250E	8RBA4-250E				(10,11)																		
300E	8RBA4-300E				(10,11)																		
400E	8RBA4-400E				(10,11)																		
8.3 kV Max (7.2 kV Nominal) 800 Amp						8.3 kV Max (7.2 kV Nominal) 800 Amp																	
450E	(2)8RBA4-250E	(9)	(2)8RBT4-250E	(12)	①	 Disconnect	(2)8RDB4-DH	7.2	8.3	95	8RDB8-VM	8RDB8-UM	RDB8-VL	RDB8-UL	8RDB4-SHNT								
540E	(2)8RBA4-300E	(9)	(2)8RBT4-300E	(12)	①			7.2	8.3	110	8RDB8-HVM	8RDB8-HUM											
720E	(2)8RBA4-400E	(9)	(2)8RBT4-400E	(12)	①																		

① Requires two fuse refills as shown. Price each refill individually.

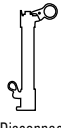
For new installation: Order one refill (Standard Speed or Time Lag), one fuseholder, one mounting, and one filter or condenser per phase. Live parts can be substituted for the mounting if user is supplying base support and insulators.

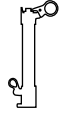

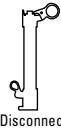



Type RDB Expulsion Fuses for Use Outdoors

Ampere Rating	Standard Speed (Fuse Refills)		Time-Lag (Fuse Refills)		Approx. Shipping Wt.	Ampere Rating	Fuseholder		Voltage (kV)			Mounting (Including Live Parts less Holder)		Live Parts		Spring and Shunt Assembly	
	Catalog Number	Curve Reference 36-635	Catalog Number	Curve Reference 36-635			Style	Catalog Number	Nominal	Max	BIL	Vertical (180°) Mounting	Underhung (90°) Mounting	Vertical	Underhung	Catalog Number	
												Catalog Number	Catalog Number				Catalog Number
RBA/RBT Refill Units						RDB Fuseholders, Mountings and Hardware (For Use with RBA/RBT Refills)											
15.5 kV Max (14.4 kV Nominal) 200Amp						15.5 kV Max (14.4 kV Nominal) 200 Amp											
10E	15RBA2-10E					10E to 200E		15RDB2-DH	13.8	15.5	110			RDB2-VL	RDB2-UL	15RDB2-SHNT	
15E	15RBA2-15E								13.8	15.5	150	15RDB2-HVM	15RDB2-HUM				
20E	15RBA2-20E		15RBT2-20E														
25E	15RBA2-25E		15RBT2-25E														
30E	15RBA2-30E		15RBT2-30E														
40E	15RBA2-40E		15RBT2-40E														
50E	15RBA2-50E	(1,2)	15RBT2-50E	(3,4)	1.1												
65E	15RBA2-65E		15RBT2-65E														
80E	15RBA2-80E		15RBT2-80E														
100E	15RBA2-100E		15RBT2-100E														
125E	15RBA2-125E		15RBT2-125E														
150E	15RBA2-150E		15RBT2-150E														
200E	15RBA2-200E		15RBT2-200E														
15.5 kV Max (14.4 kV Nominal) 400 Amp									15.5 kV Max (14.4 kV Nominal) 400 Amp								
.5E	15RBA4-.5E					.5E to 400E		15RDB4-DH	13.8	15.5	110			RDB4-VL	RDB4-UL	15RDB4-SHNT	
3E	15RBA4-3E								13.8	15.5	150	15RDB4-HVM	15RDB4-HUM				
5E	15RBA4-5E																
7E	15RBA4-7E																
10E	15RBA4-10E																
15E	15RBA4-15E																
20E	15RBA4-20E		15RBT4-20E	(7,8)													
25E	15RBA4-25E		15RBT4-25E	(7,8)													
30E	15RBA4-30E		15RBT4-30E	(7,8)													
40E	15RBA4-40E		15RBT4-40E	(7,8)													
50E	15RBA4-50E		15RBT4-50E	(7,8)													
65E	15RBA4-65E	(5,6)	15RBT4-65E	(7,8)	2.3												
80E	15RBA4-80E		15RBT4-80E	(7,8)													
100E	15RBA4-100E		15RBT4-100E	(7,8)													
125E	15RBA4-125E		15RBT4-125E	(7,8)													
150E	15RBA4-150E		15RBT4-150E	(7,8)													
200E	15RBA4-200E		15RBT4-200E	(7,8)													
250E	15RBA4-250E		15RBT4-250E	(10,11)													
300E	15RBA4-300E		15RBT4-300E	(10,11)													
400E	15RBA4-400E		15RBT4-400E	(10,11)													
15.5 kV Max (14.4 kV Nominal) 800 Amp						15.5 kV Max (14.4 kV Nominal) 800 Amp											
450E	(2)15RBA4-250E	(9)	(2)15RBT4-250E		⓪	450E		(2)15RDB4-DH	13.8	15.5	110	15RDB8-VM	15RDB8-UM	RDB8-VL	RDB8-UL	15RDB4-SHNT	
540E	(2)15RBA4-300E	(9)	(2)15RBT4-300E	(12)	⓪	540E			13.8	15.5	150	15RDB8-HVM	15RDB8-HUM				
720E	(2)15RBA4-400E	(9)	(2)15RBT4-400E		⓪	720E											

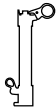
⓪ Requires two fuse refills as shown. Price each refill individually.

For new installation: Order one refill (Standard Speed or Time Lag), one fuseholder, one mounting, and one filter or condenser per phase. Live parts can be substituted for the mounting if user is supplying base support and insulators.







Type RDB Expulsion Fuses for Use Outdoors

Ampere Rating	Standard Speed (Fuse Refills)		Time-Lag (Fuse Refills)		Approx. Shipping Wt.	Ampere Rating	Fuseholder		Voltage (kV)			Mounting (including Live Parts less Holder)		Live Parts		Spring and Shunt Assembly					
	Catalog Number	Curve Reference 36-635	Catalog Number	Curve Reference 36-635			Style	Catalog Number	Nominal	Max	BIL	Vertical (180°) Mounting	Underhung (90°) Mounting	Vertical	Underhung						
												Catalog Number	Catalog Number	Catalog Number	Catalog Number						
RBA/RBT Refill Units						RDB Fuseholders, Mountings and Hardware (For Use with RBA/RBT Refills)															
25.5 kV Max (23.0 kV Nominal) 200 Amp						25.5 kV Max (23.0 kV Nominal) 200 Amp															
10E	25RBA2-10E					10E to 200E		25RDB2-DH	23.0	25.5	150			RDB2-VL	RDB2-UL	25RDB2-SHNT					
15E	25RBA2-15E																				
20E	25RBA2-20E		25RBT2-20E																		
25E	25RBA2-25E		25RBT2-25E																		
30E	25RBA2-30E		25RBT2-30E																		
40E	25RBA2-40E		25RBT2-40E																		
50E	25RBA2-50E	(1,2)	25RBT2-50E	(3,4)	1.3																
65E	25RBA2-65E		25RBT2-65E																		
80E	25RBA2-80E		25RBT2-80E																		
100E	25RBA2-100E		25RBT2-100E																		
125E	25RBA2-125E		25RBT2-125E																		
150E	25RBA2-150E		25RBT2-150E																		
200E	25RBA2-200E		25RBT2-200E																		
25.5 kV Max (23.0 kV Nominal) 400 Amp									25.5 kV Max (23.0 kV Nominal) 400 Amp												
.5E	25RBA4-.5E					.5E to 300E		25RDB4-DH	23.0	25.5	150			RDB4-VL	RDB4-UL	25RDB4-SHNT					
3E	25RBA4-3E																				
5E	25RBA4-5E																				
7E	25RBA4-7E																				
10E	25RBA4-10E																				
15E	25RBA4-15E																				
20E	25RBA4-20E		25RBT4-20E	(7,8)																	
25E	25RBA4-25E		25RBT4-25E	(7,8)																	
30E	25RBA4-30E		25RBT4-30E	(7,8)																	
40E	25RBA4-40E		25RBT4-40E	(7,8)																	
50E	25RBA4-50E		25RBT4-50E	(7,8)																	
65E	25RBA4-65E	(5,6)	25RBT4-65E	(7,8)	2.7																
80E	25RBA4-80E		25RBT4-80E	(7,8)																	
100E	25RBA4-100E		25RBT4-100E	(7,8)																	
125E	25RBA4-125E		25RBT4-125E	(7,8)																	
150E	25RBA4-150E		25RBT4-150E	(7,8)																	
200E	25RBA4-200E		25RBT4-200E	(7,8)																	
250E	25RBA4-250E		25RBT4-250E	(10,11)																	
300E	25RBA4-300E		25RBT4-300E	(10,11)																	
25.5 kV Max (23.0 kV Nominal) 800 Amp						25.5 kV Max (23.0 kV Nominal) 800 Amp															
450E	(2)25RBA4-250E	(9)	(2)25RBT4-250E	(12)	①	450E to 540E		(2)25RDB4-DH	23.0	25.5	150	25RDB8-VM	25RDB8-UM	RDB8-VL	RDB8-UL	25RDB4-SHNT					
540E	(2)25RBA4-300E	(9)	(2)25RBT4-300E	(12)	①																

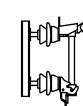
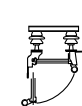
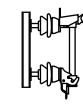
① Requires two fuse refills as shown. Price each refill individually.

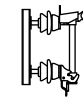
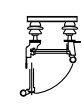
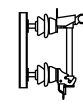
For new installation: Order one refill (Standard Speed or Time Lag), one fuseholder, one mounting, and one filter or condenser per phase. Live parts can be substituted for the mounting if user is supplying base support and insulators.

Type RDB Expulsion Fuses for Use Outdoors

Ampere Rating	Standard Speed (Fuse Refills)		Time-Lag (Fuse Refills)		Approx. Shipping Wt.	Ampere Rating	Fuseholder		Voltage (kV)			Mounting (including Live Parts less Holder)		Live Parts		Spring and Shunt Assembly								
	Catalog Number	Curve Reference 36-635	Catalog Number	Curve Reference 36-635			Style	Catalog Number	Nominal	Max	BIL	Vertical (180°) Mounting	Underhung (90°) Mounting	Vertical	Underhung	Catalog Number								
												Catalog Number	Catalog Number	Catalog Number	Catalog Number									
RBA/RBT Refill Units						RDB Fuseholders, Mountings and Hardware (For Use with RBA/RBT Refills)																		
38.0 kV Max (34.5 kV Nominal) 200 Amp						38.0 kV Max (34.5 kV Nominal) 200 Amp																		
10E	38RBA2-10E					 20E to 200E Disconnect	38RDB2-DH				 38RDB2-VM ----- 38RDB2-HVM  38RDB2-UM ----- 38RDB2-HUM 	38RDB2-VM	38RDB2-UM	RDB2-VL	RDB2-UL	38RDB2-SHNT								
15E	38RBA2-15E							34.5	38.0	200														
20E	38RBA2-20E		38RBT2-20E																					
25E	38RBA2-25E		38RBT2-25E																					
30E	38RBA2-30E		38RBT2-30E																					
40E	38RBA2-40E		38RBT2-40E																					
50E	38RBA2-50E	(1,2)	38RBT2-50E	(3,4)	1.4																			
65E	38RBA2-65E		38RBT2-65E																					
80E	38RBA2-80E		38RBT2-80E																					
100E	38RBA2-100E		38RBT2-100E																					
125E	38RBA2-125E		38RBT2-125E																					
150E	38RBA2-150E		38RBT2-150E																					
200E	38RBA2-200E		38RBT2-200E																					
38.0 kV Max (34.5 kV Nominal) 400 Amp								38.0 kV Max (34.5 kV Nominal) 400 Amp																
.5E	38RBA4-.5E							 .5E to 300E Disconnect	38RDB4-DH										 38RDB4-VM ----- 38RDB4-HVM  38RDB4-UM ----- 38RDB4-HUM 	38RDB4-VM	38RDB4-UM	RDB4-VL	RDB4-UL	38RDB4-SHNT
3E	38RBA4-3E					34.5	38.0			200														
5E	38RBA4-5E																							
7E	38RBA4-7E																							
10E	38RBA4-10E																							
15E	38RBA4-15E																							
20E	38RBA4-20E		38RBT4-20E	(7,8)																				
25E	38RBA4-25E		38RBT4-25E	(7,8)																				
30E	38RBA4-30E		38RBT4-30E	(7,8)																				
40E	38RBA4-40E		38RBT4-40E	(7,8)																				
50E	38RBA4-50E	(5,6)	38RBT4-50E	(7,8)	3.1																			
65E	38RBA4-65E		38RBT4-65E	(7,8)																				
80E	38RBA4-80E		38RBT4-80E	(7,8)																				
100E	38RBA4-100E		38RBT4-100E	(7,8)																				
125E	38RBA4-125E		38RBT4-125E	(7,8)																				
150E	38RBA4-150E		38RBT4-150E	(7,8)																				
200E	38RBA4-200E		38RBT4-200E	(7,8)																				
250E	38RBA4-250E		38RBT4-250E	(10,11)																				
300E	38RBA4-300E		38RBT4-300E	(10,11)																				
38.0 kV Max (34.5 kV Nominal) 800 Amp						38.0 kV Max (34.5 kV Nominal) 800 Amp																		
450E	(2)38RBA4-250E	(9)	(2)38RBT4-250E	(12)	ⓐ	 450E to 720E Disconnect	38RDB4-NH				 38RDB8-VM ----- 38RDB8-HVM  38RDB8-UM ----- 38RDB8-HUM	38RDB8-VM	38RDB8-UM	RDB8-VL	RDB8-UL	38RDB4-SHNT								
540E	(2)38RBA4-300E	(9)	(2)38RBT4-300E	(12)	ⓑ				34.5	38.0							200							

ⓐ Requires two fuse refills as shown. Price each refill individually.

For new installation: Order one refill (Standard Speed or Time Lag), one fuseholder, one mounting, and one filter or condenser per phase. Live parts can be substituted for the mounting if user is supplying base support and insulators.



DBU Fuses

Introduction

The Cutler-Hammer DBU Power Fuse is a Boric Acid, expulsion-style fuse unit. Suitable for both indoor and outdoor applications, the DBU provides a low initial cost alternative to refillable fuses.



New DBU with End Fittings

In comparison to the conventional distribution cutout that utilizes the fiber tube and fuse link design for fault interruption, the DBU far exceeds the cutout in interrupting rating, and considerably reduces the hazards and noise of the violent exhaust common to cutouts under fault interrupting conditions. The DBU fuse employing the use of calibrated silver elements, boric acid for its interrupting media, and the mechanical utilization of the spring and rod mechanism, creates a technique which gives a low arc and mild exhaust fault interruption.

DBU Expulsion Fuses are available in 3 maximum voltage classes: 17kV, 27kV, and 38kV. The replaceable fuse unit comes in 3 speed variations: Standard "E", Slow "E", and "K". Amperage sizes range from 3 Amps through 200 Amps.

Construction

In terms of application, the complete fuse consists of the fuse unit, end fittings, and a mounting.

Principle parts of the replaceable DBU fuse unit are shown in the cross section view of Fig. 9. Main operating parts are the silver element, arcing rod, boric acid cylinder, and spring. To prevent warping under outdoor conditions and assure adequate strength to contain the force of the arc interruption, a glass epoxy tube encloses the assembly.

The use of a pure silver element and Nichrome wire strain element makes the DBU less susceptible to outages caused by vibration, corona corrosion, and aging of the fuse elements. It is not damaged by transient faults or overloads which approach the minimum melt point.

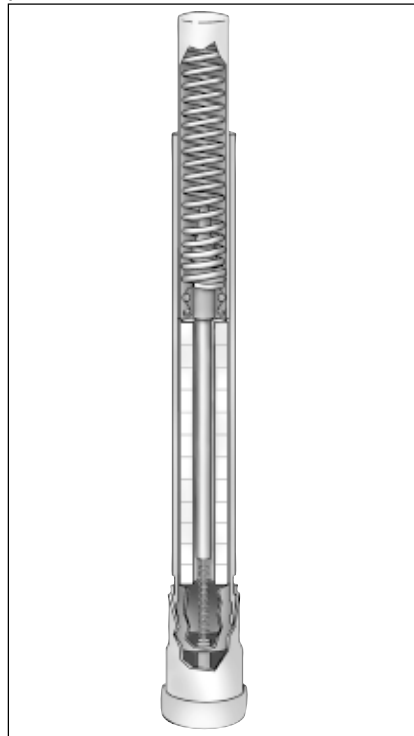

Figure 9: DBU Fuse Construction

The components are housed in a fiberglass reinforced resin tube with plated copper contacts. Positive connection is maintained between the arcing rod and contact

with a sliding tulip contact. A durable weatherproof label is located on each fuse which provides ratings and manufacturer information.

Operation

DBU Expulsion Fuses utilize the proven performance of boric acid to create the de-ionizing action needed to interrupt the current. Fault interruption is achieved by the action of an arcing rod and a charged spring, elongating the arc through a boric acid chamber upon release by the fuse element.



At high temperatures, boric acid decomposes producing a blast of water vapor and inert boric anhydride. Electrical interruption is caused by the steam extinguishing the arc, as the arc is being elongated through the cylinder.

Higher particle turbulence of the boric acid causes the rate of de-ionization in the cylinder to exceed the ionization of the electrical arc. Both high and low current faults are interrupted in the same manner with no foreign material other than the boric acid required. This enables the fuse to interrupt short circuits within one-half cycle and

prevents the arc from restriking after a current zero.

After interruption, the gases are expelled from the bottom of the fuse. The arcing rod is prevented from falling back into its original position by a friction stop at the top of the fuse unit.

When the fuse operates, the upward motion of the spring forces the top of the arcing rod to penetrate the upper seal, striking the latch mechanism. On indoor applications, this action caused the blown fuse indicator to actuate.

On outdoor installations, the latch releases the fuse unit allowing the ejector spring to move the assembly outward and swing through a 180 degree arc into a dropout position. This dropout action provides immediate visual indication that the fuse has operated. When the fuse is blown and the dropout action completed, the entire unit is removed with a hookstick.

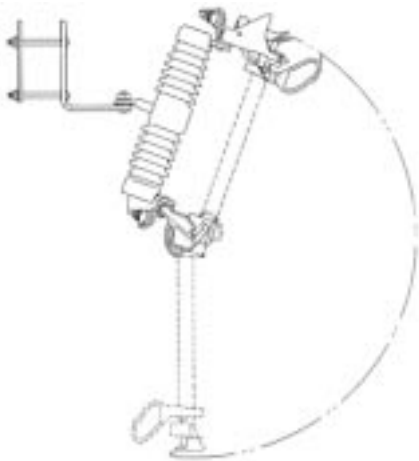

Outdoor dropout action.

When replacing the blown fuse, the end fittings should be removed from the operated fuse unit, and if undamaged, clamped onto the new fuse unit.

Application

The DBU Power Fuse provides effective protection for circuits and equipment which operate on voltage systems up to 34,500V. They can be used on both electric utility and industrial distribution systems and all fuses are designed for use on the following:

- Power Transformers
- Feeder Circuits
- Distribution Transformers
- Potential Transformers
- Station Service Transformers
- Metal-enclosed Switchgear
- Pad Mount Switches

DBU Fuse units can be used in outdoor or indoor applications, and can be used to directly replace competitive equivalent units.



WLI gear w/ Fuses

Since the DBU Fuse Unit has superb, reliable performance characteristics, it can be used on upstream as well as downstream applications.

Regarding upstream system protection, the DBU operates promptly to limit the stress on electrical systems due to short circuits. It provides isolation for the faulted circuit, limiting the amount of interruption to the service. Downstream equipment is equally protected. The DBU acts rapidly to take transformer and feeder circuits off-line before damage can become widespread. It provides excellent isolation for capacitors as well in the event of a fault condition.

When installed on the primary side of substation power transformers, DBU fuses provide protection against small, medium or large faults. Regardless of the nature of the fault, full protection is provided even down to minimum melt current.

DBU Details

The Cutler-Hammer DBU provides superior performance especially intended for distribution system protection up to an operational voltage of 34.5KV. Because the DBU is available in various current ratings and time-current characteristics, close fusing can be achieved to maximize protection and overall coordination. The quality of the DBU design and manufacturing process ensures repeatable accuracy and ongoing time-current protection.

DBU Fuse Unit

A DBU fuse unit is comprised of an arcing rod, an auxiliary arcing wire, a strain element, and a solid boric acid liner which assists with the interruption. All of these components are contained within a separate fiberglass tube. The fiberglass tube has an end cap on one end with a blowout disk which permits exhaust to exit during interruption. The fuse element determines the operational time-current characteristics of the DBU fuse unit. How the fuse reacts for different magnitudes of current and amounts of time is indicated on the specific time-current characteristic curve. The DBU is available in

Standard "E", "K", and Slow "E" configurations.

The heavy copper cylindrical arcing rod is contained within the main bore of the boric acid liner and performs two functions. Under normal conditions, it conducts the continuous rated current of the fuse.

A nichrome wire, called the strain element, parallels the fuse element and relieves the fuse element of any strain put on it by the spring loaded arcing rod. The high resistance wire shunts the fuse element and vaporizes immediately after the fuse element melts.

When the fuse element melts during a fault condition, the arcing rod draws and lengthens the arc as it moves up through the boric acid liner. This movement is caused by spring tension placed on the arcing rod by the attached charged spring.

Intense heat from the arc decomposes the dry boric acid. On decomposition, the boric acid forms water vapor and inert boric

anhydride which by blasting through it, extinguishes and de-ionizes the arc.

The exhaust caused by the interruption exits from the bottom of the fuse through the blowout disk. This prevents the arc from restriking after a current zero.

The replaceable DBU fuse unit is discarded after it interrupts a fault.

DBU End Fittings

End Fittings are required to complete the electrical connection between the fuse unit and the live parts and mounting.

End fittings are positioned on the top and bottom of the fuse unit. They can be used over again if they remain undamaged.

End Fittings are available in 2 versions: indoor and outdoor.

The indoor fittings accept a Muffler attachment to limit noise and contamination to indoor equipment. The blown fuse

indicator located on the top end fitting, provides visual indication of a faulted fuse unit.

Outdoor Fittings

Outdoor end fittings are made of a cast-copper plated alloy. A large hookeye on the upper fitting allows for easy installation into pole-top mountings with a hookstick. The pivotal design of this hookeye provides for proper engagement of the upper live part. The positive locking action of the latch mechanism prevents detachment from the mounting due to shock or vibration. In the event of a fault, the arcing rod will penetrate through the upper end of the fuse unit, and cause the latch to release. Once released, the fuse will rotate down into the drop-out position to indicate a blown-fuse condition.

The lower end fitting has two cylindrical posts that insert into the lower live part of the mounting. These posts allow the fuse to rotate into the proper engaged position, and suspend the fuse during a blown, drop-out condition.

Indoor DBU Fuse Fittings

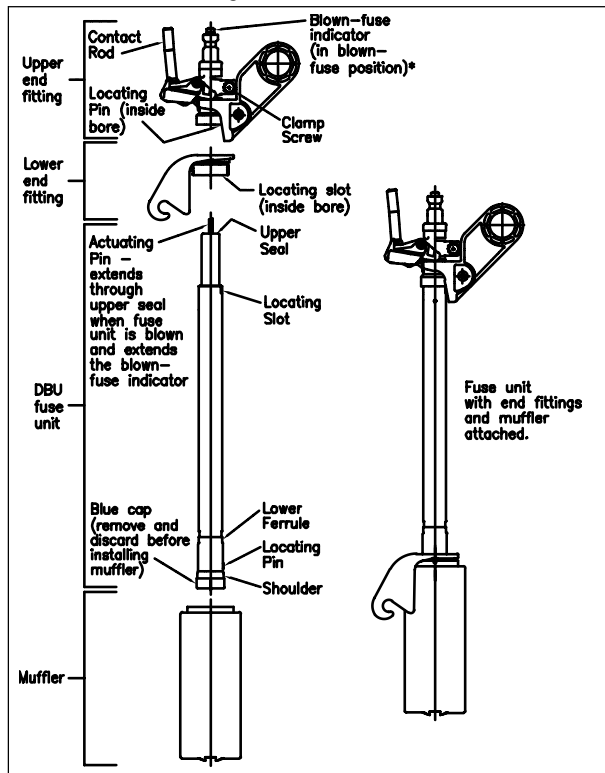

Outdoor DBU Fuse Fittings

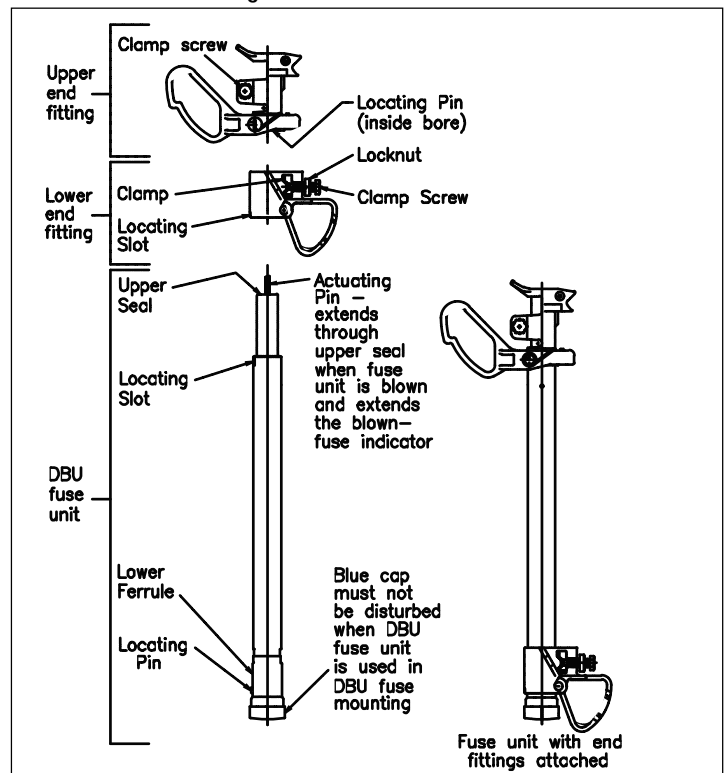

Indoor Fittings

The indoor end fittings are composed of high-impact plastic and high-conducting copper alloy. The blown fuse indicator located on the top end fitting, provides visual indication of a faulted fuse unit. The silver-plated contact rod insures positive conductivity between the fuse unit and the live parts of the mounting.

The spring-loaded plastic mounting handle actuates the latch mechanism when engaged into the mounting. It readily accepts a hookstick to install or remove the assembled fuse unit.

A locating pin in the upper fitting assures proper alignment and engagement with the fuse unit.

The cast bottom indoor fitting has a locating slot on the inside bore. This slot aligns with a locating pin on the lower section of the fuse unit to provide proper alignment with the fuse unit and the mounting. Two pivotal slots are formed into the fitting for mechanical insertion into the mounting.

The bottom indoor fitting is threaded to accept a Muffler attachment for limiting noise and contamination to indoor equipment. The Muffler is constructed of a plated steel housing, containing copper mesh screening. This copper mesh acts to absorb and contain the noise and exhaust materials of the fuse during a fault condition. The Muffler prevents contamination of indoor components and mechanisms located within the switchgear. This containment action also prevents accidental flash-over from phase-to-phase or phase-to-ground by limiting foreign airborne particles and gases.

All end fittings are re-usable if undamaged. They are completely interchangeable with other manufacturers' equivalent fuse units and mountings.

Mountings & Live Parts

Cutler-Hammer offers a full line of loadbreak and non-loadbreak mountings and live parts for the DBU fuse family. Mountings are

available in 17KV, 27KV, and 38KV class designs.

These mountings will readily accommodate all DBU class fuses as well as other equivalent manufacturers.

All mountings are applicable for indoor applications of pad-mount and switchgear designs.

Units have a maximum current rating up to 200A, with a maximum interrupt rating of 14kA. The following lists the BIL rating of each voltage class:

- 17KV - 95 BIL
- 27KV - 125 BIL
- 38KV - 150 BIL

Loadbreak units have a maximum 3-time fault close ASYM of 22,400A RMS. Refer to the catalog number section for exact ratings per unit.



Non-Loadbreak Mounting



Loadbreak Mounting

Mountings are constructed of rigid steel bases. Non-load break units are galvanized while loadbreak styles are epoxy coated. Bases are supplied with preformed mounting holes for easy installation.

Isolators are molded of cycloaliphatic material for superior insulating characteristics. Live parts are rigidly secured to the isolators with standard mounting hardware.

Bus for cable terminations for non-loadbreak units are located on the

right side of the mountings. Loadbreak units have both left and right side mountings available for proper installation spacing. All bus connections are plated copper for improved conductivity and endurance.

All loadbreak units have a 3 time fault close rating. These fuse mountings can withstand a fuse assembly being closed into a fault of the magnitude specified three times when closed briskly without hesitation, and remain operable and able to carry and interrupt the continuous current.

All live parts are constructed of silver-plated copper to ensure maximum and sustained conductivity.

Live parts can be purchased as separate kits without mountings.

DBU Interruption and Protection

Discussions have concentrated on the individual components that make up a DBU Power Fuse. This section will center around the operation of the complete fuse assembly.

When completely assembled, the DBU Power Fuse will provide effective protection for circuits and equipment which operates on voltages from 2400 Volts through 34,500 Volts. At this point, it would be beneficial to briefly review the overall operation of the entire DBU Power Fuse.

The DBU assembly, whether disconnect or non-disconnect, is positioned to perform its protective function as current flows through the mounting's line and load connectors. The DBU fuse unit makes the electrical connection with the mounting through its end fittings when properly engaged. A spring-loaded arcing rod carries the normal continuous current through the unit when the circuit is operational. Under normal conditions, the fusible element's temperature is below its melting temperature and does not melt. When a fault occurs that is

large enough to melt the fuse element, an arc is initiated and elongated by the units spring, pulling the arcing rod up into the boric acid interrupting media. The heat produced decomposes the boric acid liner inside producing water vapor and boric anhydride which helps to de-ionize the arc. The by-products extinguish the arc at a natural current zero by blasting through it and exiting out the bottom of the fuse. When installed indoors, the exhaust and noise produced during the interruption process are limited by the muffler attached to the lower end fitting. The DBU fuse unit is then discarded, and replaced with a new unit, re-using the end fittings if undamaged.

This assembly is then re-engaged into the live parts and mounting. Although the process is more involved than just described, this should provide a general understanding of how the DBU Power Fuse works to provide outstanding and economical protection with limited down time.

During the interrupting process, current continues to flow in the circuit and in the fuse until a current zero is reached. When the arc is stopped at current zero, the voltage will attempt to re-ignite the arc. The voltage across the fuse terminals builds dramatically and is referred to as the Transient Recovery Voltage (TRV). The TRV is the most severe waveform the fuse will have to withstand. This voltage build-up puts a great deal of potentially destructive force on the fuse units and the system in total. Whether or not extinguishing of the arc is successful depends, in general, on the dielectric strength between the fuse terminals. In short, the dielectric strength between the fuse terminals must be greater than the voltage trying to re-ignite the arc for a successful interruption to occur. When properly applied, the DBU Power Fuse has a dielectric recovery that is greater than the TRV, regardless of the fault current. (Refer to Table 1)

The maximum voltage rating of the DBU fuse is the highest rms voltage at which the fuse is designed to operate. Its dielectric withstand level corresponds to insulation levels of power class equipment, thus the name "power fuse". Maximum voltage ratings for DBU Power Fuses are: 17KV, 27KV, and 38KV.

No fuse should ever be applied where the available fault current exceeds the interrupting rating of the fuse. The rated interrupting capacity of the DBU is the rms

value of the symmetrical component (AC component) of the highest current which the DBU is able to successfully interrupt under any conditions of asymmetry. In short, the interrupting rating must be equal to or greater than the maximum symmetrical fault current at the point where the fuse is applied. The DBU has interrupting capabilities from 10,000 to 14,000 amperes symmetrical.

The continuous current rating of a DBU Power Fuse should equal or

Table 1: TRV Characteristics

Fuse Rating kV Normal	Primary Faults			Secondary Faults		
	Test Circuit - Normal Frequency Recovery Voltage, kV rms	TRV Natural Frequency, Kc	TRV Amplitude Factor	Test Circuit - Normal Frequency Recovery Voltage, kV rms	TRV Natural Frequency, Kc	TRV Amplitude Factor
14.4	17.1	5.5	1.6	14.4	17	1.7
25	27	5.5	1.6	27	13	1.7
34.5	38	3.9	1.6	38	6.5	1.7

Table 2: DBU Power Fuse Short-Circuit Interrupting Ratings

kV, Nominal		Amperes, Interrupting		MVA, Interrupting (Three-Phase Symmetrical)
DBU	System	Symmetrical based on X/R = 15	Asymmetrical	Where X/R = 15
17	7.2	14000	22400	175
	4.8 / 8.32Y			200
	7.2 / 12.47Y			300
	7.62 / 13.2Y			320
	13.8			335
	14.4			350
27	16.5	12500	20000	400
	7.2 / 12.47Y			270
	7.62 / 13.2Y			285
	13.8			300
	14.4			310
	16.5			365
	23.0			500
	14.4 / 24.9Y			540
20 / 34.5Y ①	...			
38	23.0	10000	16000	...
	14.4 / 24.9Y			...
	27.6			475
	20 / 34.5Y			600
34.5	600			

① Applies to 23kV Single-Insulator Style only, for Protection of single-phase-to-neutral circuits (line or transformers) and three-phase transformers or banks with solidly grounded neutral connections.

exceed the maximum load current where the fuse is applied. They are designed to carry their rated continuous current without exceeding the temperature rise outlined in NEMA and ANSI standards.

The DBU is available with continuous current ratings up to 200 amperes. The current ratings carry an "E" designation as defined by ANSI and NEMA. For example, the current responsive element rated 100E amperes or below shall melt in 300 seconds at an rms current within the range of 200 to 240 percent of the continuous current ratings. Above 100E amperes, melting takes place in 600 seconds at an rms current within the range of 220 to 264 percent of the continuous current rating. Slow "E" and "K" speeds are also available.

Coordination Consideration

Coordination considerations must be made to help determine what type of fuse is applied. The DBU Power Fuse interrupts at a natural current zero in the current wave and allows a minimum of a half cycle of fault current to flow before the fault is cleared. The time-current characteristics associated with a DBU has a rather gradual slope making it easier to coordinate with downstream equipment. In addition, the DBU is ideal for higher voltage (up to 38 kV) and high current applications (thru 200 Amps). It is important to examine the minimum melting and total clearing time-current characteristics of this particular fuse.

The melting time is the time in seconds required to melt the fuse element. This curve indicates when or even if the element of the fuse will melt for different symmetrical current magnitudes.

The total clearing time is the total amount of time it takes to clear a fault once the element has melted. The total clearing time is really the sum of the melting time

and the time the fuse arcs during the clearing process.

The DBU Power Fuse is offered in 3 configurations for use with high currents: "E" (Standard), "K" (Fast) and "SE" (Slow). The curves for the "SE" are less inverse and allow for more of a time delay at high currents.

Finally, low currents, usually referred to as overload currents, must also be considered. The DBU and other expulsion fuses have a rather low thermal capacity and cannot carry overloads of the same magnitude and duration as motors and transformers of equal continuous currents. For this reason, the fuse must be sized with the full load current in mind. This consideration should be made so the fuse does not blow on otherwise acceptable overloads and inrush conditions.

The Cutler-Hammer DBU family of power fuses is broad and comprehensive. Refer to the DBU Ratings Table 2 to review the ratings available for most application requirements. The final selection process for new applications will include the fuse unit, end fittings, and a mounting.

Non-Loadbreak Mounting

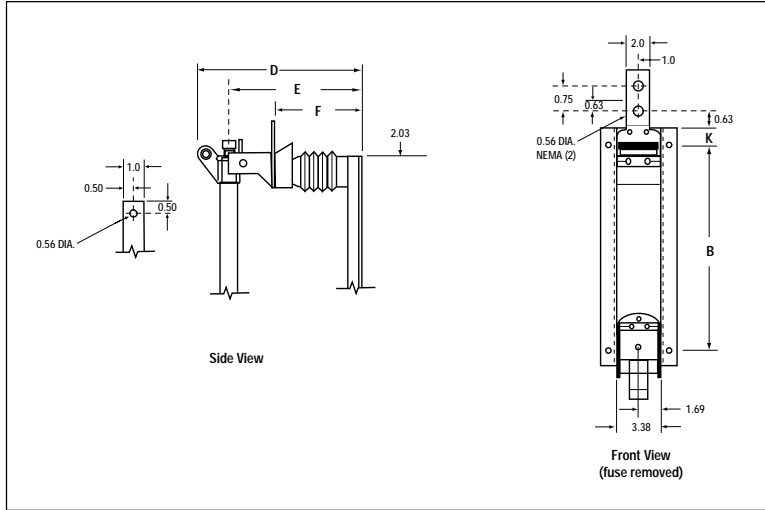

kV Max.	Catalog Number*	kV BIL	Fuse Mounting (Dimensions in Inches)				
			B	D	E	F	K
17	DBU17-GNM	95	17.75	17.63	12.63	9.50	3.0
27	DBU27-GNM	95	22.25	19.19	14.44	11.06	3.0
38	DBU38-GNM	150	28.25	22.0	17.25	13.63	3.0

* Bus for cable termination on right side of mounting.

Indoor DBU Fuse Fittings

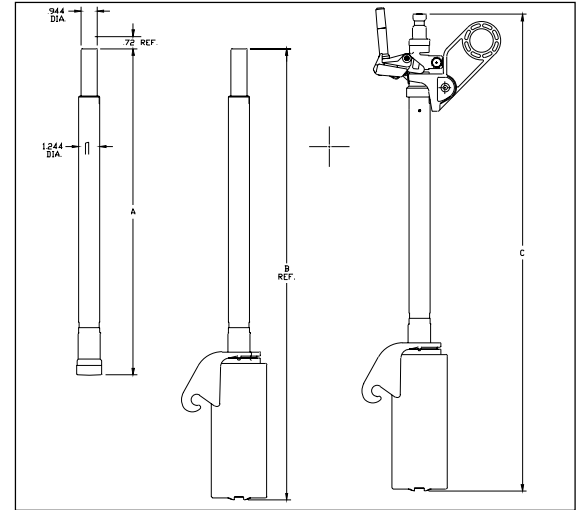

kV Max.	Fuse Unit Fittings		
	A	B	C
17	19.08	27.19	28.82
27	22.58	30.69	32.32
38	28.76	36.87	38.50

Loadbreak Mounting

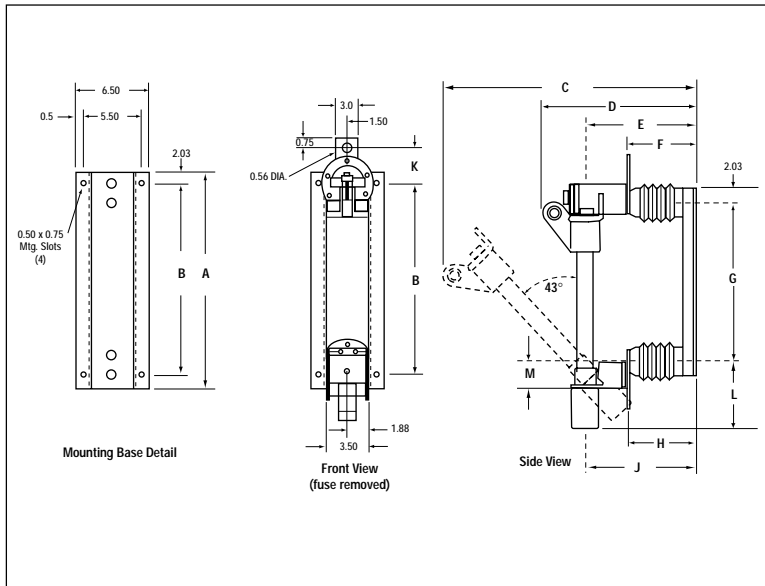

kV Max.	Catalog Number	kV BIL	Fuse Mounting (Dimensions in Inches)											
			A	B	C	D	E	F	G	H	J	K	L	M
17	DBU17-GDML**	95	22.50	18.44	30.50	19.25	14.25	9.25	18.44	9.44	11.50	3.0	9.50	3.75
17	DBU17-GDMR*	95	22.50	18.44	30.50	19.25	14.25	9.25	18.44	9.44	11.50	3.0	9.50	3.75
27	DBU17-GDML**	125	26.75	22.69	34.63	21.38	16.75	11.56	22.69	11.75	13.50	3.0	9.50	3.75
27	DBU17-GDMR*	125	26.75	22.69	34.63	21.38	16.75	11.56	22.69	11.75	13.50	3.0	9.50	3.75
38

* Bus for cable termination on right side of mounting.
 * Bus for cable termination on left side of mounting.

Outdoor DBU Fuse Fittings

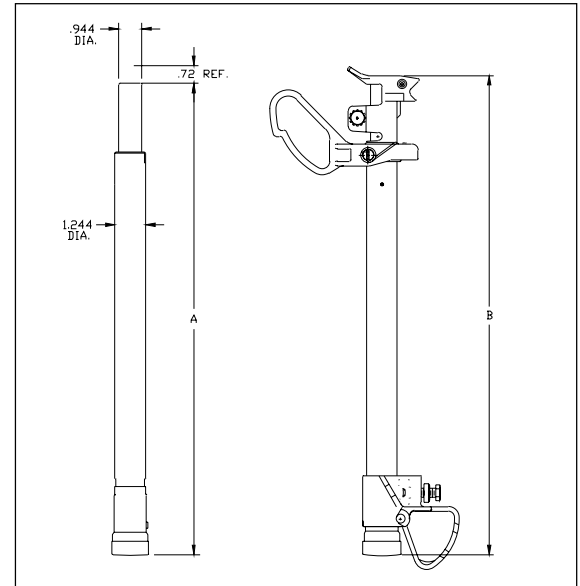

kV Max.	Fuse Unit Fittings	
	A	B
17	19.08	19.41
27	22.58	22.91
38	28.76	29.09

Testing and Performance

■ Standards

■ Testing

■ Quality Standards

Cutler-Hammer does not compromise when performance, quality and safety are involved. Exacting standards have been established relative to the design, testing and application of expulsion type power fuses. Compliance with these standards ensures the best selection and performance.

Type DBU Power Fuses are designed and tested to applicable portions of ANSI standards as well as other industry standards. The ANSI standards are Consensus Standards jointly formulated by IEEE and NEMA.

IEEE (Institute of Electrical and Electronic Engineers) is an objective technical organization made up of manufacturers, users and other general interest parties. NEMA (National Electrical Manufacturers Association) is an electrical equipment manufacturer only organization with members like Cutler-Hammer. ANSI (American National Standards Institute) is a nonprofit, privately funded membership organization that coordinates the development of U.S. voluntary national standards. It is also the U.S. member body to the non-treaty international standards bodies, such as International Organization for Standardization (ISO) and the International Electrotechnical Commission (IEC).

The specific standards associated with DBU Power Fuses are:

- ANSI C37.40 - Service Conditions and Definitions
- ANSI C37.41 - Power Fuse Design and Testing
- ANSI C37.42 - Distribution Fuse Ratings and Specification
- ANSI C37.46 - Power Fuse Ratings and Specifications

- ANSI C37.48 - Power Fuse Application, Operation and Maintenance

Testing

DBU Power Fuse unit design testing was performed on standard production fuses, holders, mountings and accessories. Demanding tests were performed at the Cutler-Hammer Technical Center and also at recognized independent power testing laboratories. Thermal and interrupting testing was conducted at 17, 27, and 38kV levels. The entire series of tests was conducted in a specific sequence as stipulated by governing standards without any maintenance being performed. All test results are verified by laboratory tabulations and oscillogram plots.

Quality

Every effort is made to ensure the delivery of quality fuse units and customer satisfaction. All Cutler-Hammer fuses are completely inspected at each manufacturing stage.

In addition to ongoing quality control inspections, testing is performed prior to shipment. A Micro-Ohm Resistance Test is performed on each fuse to assure proper element construction, alignment and tightness of electrical connections. Construction integrity testing is also performed on every unit.

Each DBU fuse unit is checked to ensure that all items are supplied in keeping with manufacturing drawings. Individual fuses are packed in a plastic bag and then put into individual cartons. In addition, fuses are overpacked in a shipping carton to prevent shipping damage. Finally, mountings are packaged in heavy cardboard containers with reinforced wooden bases.

1. Installation for New DBU Applications

1.1 Installation (Fusing) in Pad-Mount/Indoor Applications with Exhaust Control Device

Attach fuse-unit end fittings (Fig. 10) as follows:

- A. The lower end fitting must be attached first. Remove and discard the blue cap located on the lower end of the fuse unit. Next, slip the lower end fitting over the upper end of the fuse unit and slide it down until the locating slot is seated on the locating pin of the lower ferrule. Then thread the Exhaust Control Device onto the lower end fitting and screw it on firmly. The final fractional turn should be made with a bar or wrench handle.
- B. Slip the upper end fitting over the fuse unit. Align the locating pin (inside the upper end fitting) with the locating slot in the Fuse Unit and seat the upper end fitting firmly against the upper end of the Fuse Unit. Tighten the clamp screw firmly.

CAUTION

ANY AND ALL APPLICABLE SAFETY REGULATIONS MUST BE STRICTLY ADHERED TO CONCERNING THE CLOSURE OR POSSIBLE CLOSURE OF DBU FUSE UNITS ONTO "LIVE" CIRCUITS.

1.1.1 Unused Fuse-Unit End Fittings

A coating of oxidation-inhibiting grease was applied to the contact rod at the factory. Verify the presence of the oxidation-inhibiting grease, and that it is still free of (from) contaminants. If necessary, clean the contact rod with a nontoxic, nonflammable solvent and apply a coating of oxidation-inhibiting grease. End Fittings should be stored in the original shipping package (if possible) in an area free from excessive moisture. End Fittings should only be attached immediately prior to installation.

1.1.2 Re-used Fuse-Unit End Fittings

Remove the existing coating of oxidation-inhibiting grease, and dirt from the contact rod using a nontoxic, nonflammable solvent. Inspect the contact rod for evidence of pitting. If pitting has occurred, file down any projections, abrade the surface, until smooth with an abrasive cloth or scratch brush, and wipe clean. Apply a new coating of oxidation-inhibiting grease, to the contact rod. If the contact has been burned, the contact and its mating part should be replaced.

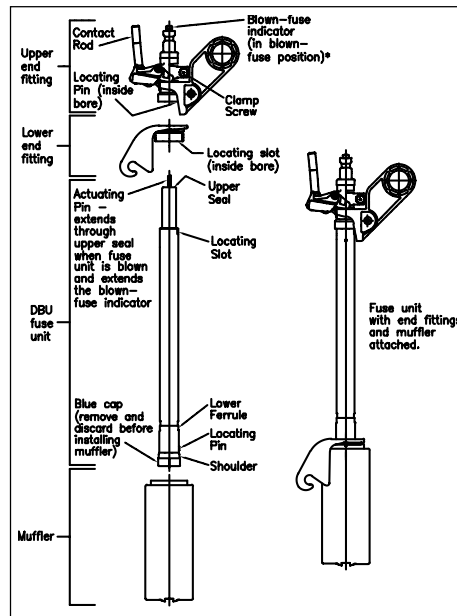

Figure 10: Indoor DBU Fuse Fittings

1.2 Installation (Fusing) in Outdoor Mountings

Attach the fuse-unit end fittings (Fig. 11) as follows:

- A. The lower end fitting must be attached first. Slip the lower end fitting over the upper end of the fuse unit and slide it down until the locating slot seats on the locating pin of the lower Fuse Unit ferrule. Next, back off the locknut on the clamp screw and tighten the clamp screw firmly; secure it with the locknut.
- B. Slip the upper end fitting over the fuse unit. Align the locating

pin (inside the upper end fitting) with the locating slot in the Fuse Unit and seat the upper end fitting firmly against the upper end of the Fuse Unit. Tighten the clamp screw firmly. Do not remove the blue outer cap from the bottom of the Fuse Unit.

1.2.1 Unused Fuse-Unit End Fittings

A coating of oxidation-inhibiting grease was applied to the contact rod at the factory. Verify the presence of this oxidation-inhibiting grease, and that it is still free of (from) contaminants. If necessary, clean the contact rod with a nontoxic, nonflammable solvent and apply a coating of oxidation-inhibiting grease. End Fittings should be stored in the original shipping package (if possible) in an area free from excessive moisture. End Fittings should only be attached immediately prior to installation.

1.2.2 Re-used Fuse-Unit End Fittings

Remove the existing coating of oxidation-inhibiting grease, and dirt from the contact rod using a nontoxic, nonflammable solvent. Inspect the contact rod for evidence of pitting. If pitting has occurred, file down any projections, abrade the surface, until smooth with an abrasive cloth or scratch brush, and wipe clean. Apply a new coating of oxidation-inhibiting grease, to the contact rod. If the contact has been burned, the contact and its mating part should be replaced.

2. Replacement of existing Applications

2.1 Replacement (Refusing) in Pad-Mount/Indoor Applications with Exhaust Control Device

- A. When the fuse operates, the fuse unit does not swing open but the blown-fuse indicator moves to the extended position, providing visual evidence that the Fuse Unit has operated. Move the Fuse Unit to the open position and then remove it from the

mounting. Note: Non-loadbreak mountings do not incorporate a live switching device. Hence, an unblown DBU Fuse Unit in such mountings must not be moved to the open position without first opening an upstream series interrupting and isolating switch or loadbreak elbow.

- B. Loosen the upper end fitting clamp screw, and pry the clamp apart slightly using a screwdriver. Slide the upper end fitting off the upper end of the Fuse Unit. Then unscrew and remove the Exhaust Control Device. Slide the lower end fitting off the upper end of the Fuse Unit. (Refer to Figure 10.)
- C. Attach the end fittings and muffler to a new Fuse Unit, following the instructions given above. A Fuse Unit that has operated cannot be salvaged. Discard it.
- D. To avoid delay due to transferring of end fittings, spare sets of end fittings and exhaust control devices may be kept on hand for attachment to new Fuse Units immediately before re-fusing is to be performed.

The use of a pure silver element and Nichrome strain element makes the DBU less susceptible to outages caused by vibration, corona corrosion, and aging of the fuse elements, nor is it damaged by transient faults or overloads which approach the minimum melting point.

2.2 Replacement (Refusing) in Outdoor Mountings

- A. When the fuse operates, the Fuse Unit swings to the open position. Remove it from the mounting, using a universal pole equipped with a suitable fuse handling attachment. Examine the end of the fuse unit to determine that the actuating pin (see Figure 11) extends through the upper seal, indicating that the fuse unit has operated.

- B. Loosen the upper and lower end fitting clamp screws (pry the upper end fitting clamp apart slightly with a screwdriver), and slide both end fittings off the upper end of the Fuse Unit.
- C. Next, attach the end fittings to a new Fuse Unit, following the instructions given above. A Fuse Unit that has operated cannot be salvaged. Discard it.
- D. To avoid delay due to transferring of end fittings, spare sets of end fittings may be kept on hand for attachment to new Fuse Units immediately before re-fusing is to be performed.

2.2.1 Unused Fuse-Unit End Fittings

A coating of oxidation-inhibiting grease was applied to the contact rod at the factory. Verify the presence of this oxidation-inhibiting grease, and that it is still free of (from) contaminants. If necessary, clean the contact rod with a nontoxic, nonflammable solvent and apply a coating of

oxidation-inhibiting grease. End Fittings should be stored in the original shipping package (if possible) in an area free from excessive moisture. End Fitting should only be attached immediately prior to installation.

2.2.2 Re-used Fuse-Unit End Fittings

Remove the existing coating of oxidation-inhibiting grease, and any dirt from the contact rod using a nontoxic, nonflammable solvent. Inspect the contact rod for evidence of pitting. If pitting has occurred, file down any projections, abrade the surface, until smooth with an abrasive cloth or scratch brush, and wipe clean. Apply a new coating of oxidation-inhibiting grease, to the contact rod. If the contact has been burned, the contact and its mating part should be replaced.

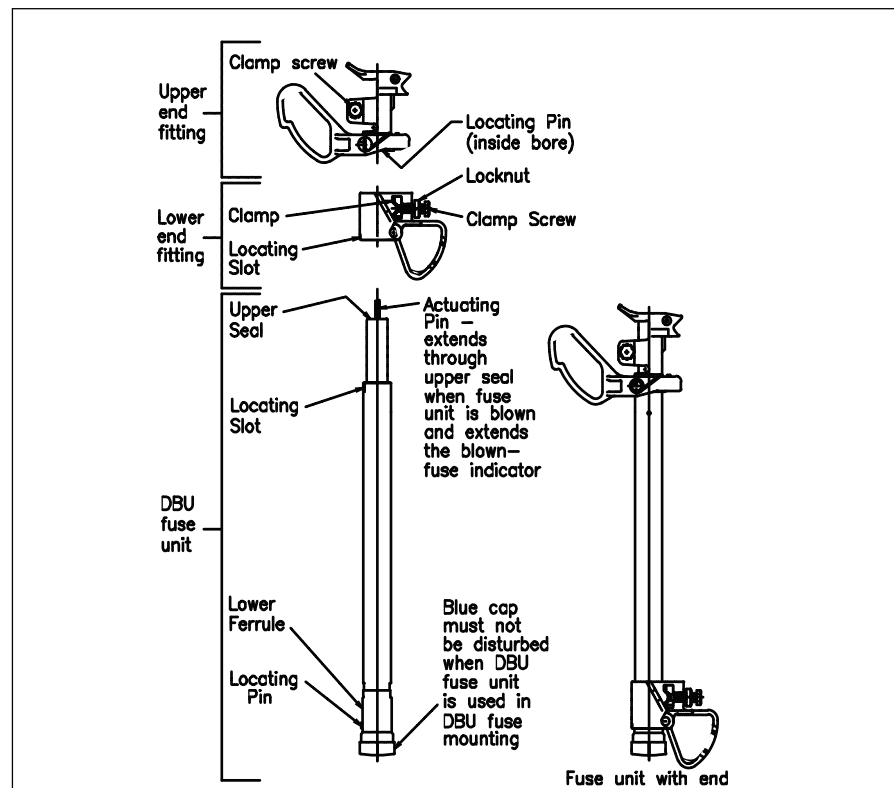
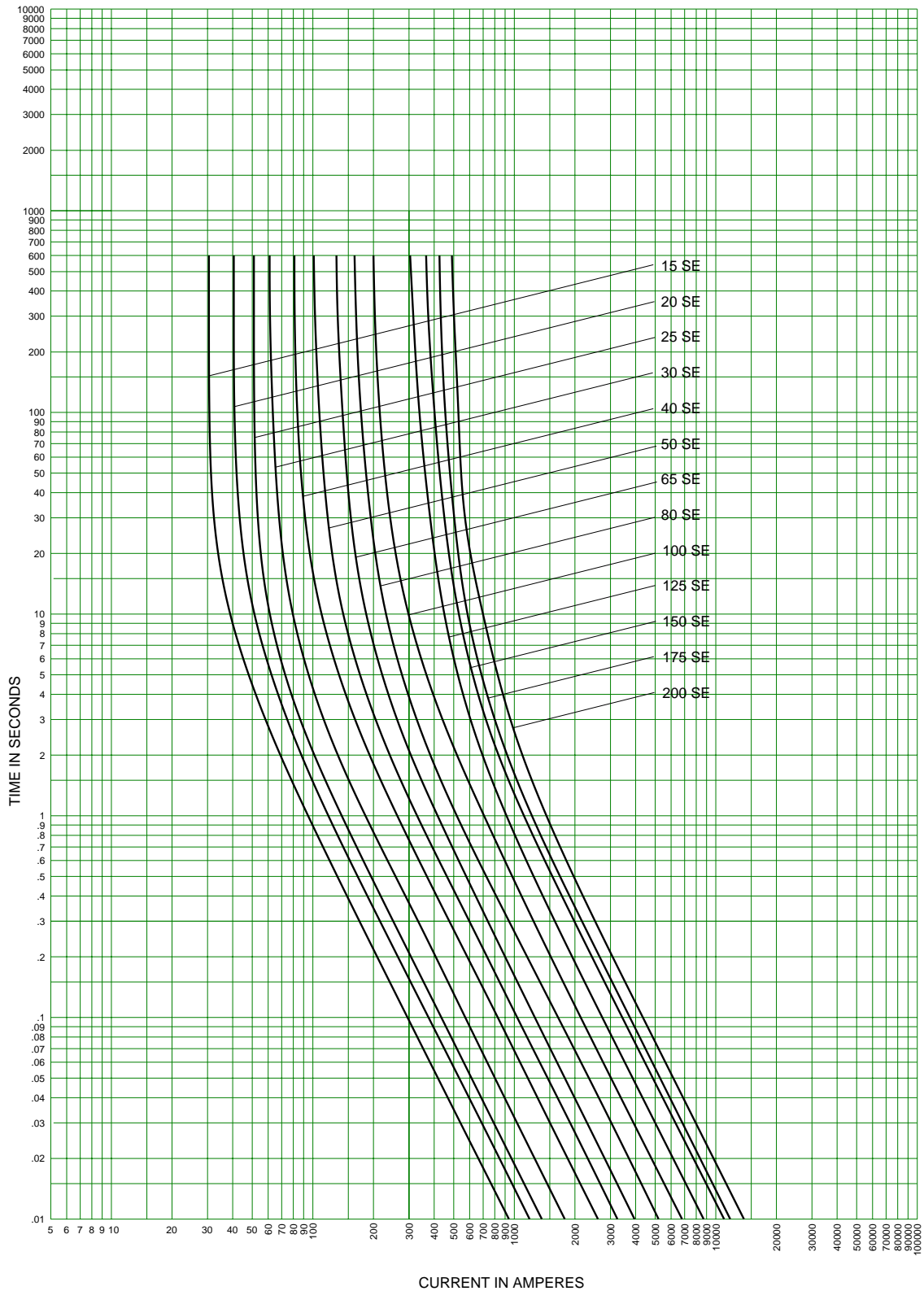

Figure 11: Outdoor DBU Fuse Fittings



Type DBU Slow E Speed Fuses
 Minimum Melting Time-Current Characteristics - 17.1 - 38 kV

CURVE 36-643 # 10
 July 21, 1999
 Reference # 667026

Curves are based on tests starting with fuse unit at ambient temperature of 25°C and without initial load.
 Curves are plotted to minimum test points so all variations should be positive.

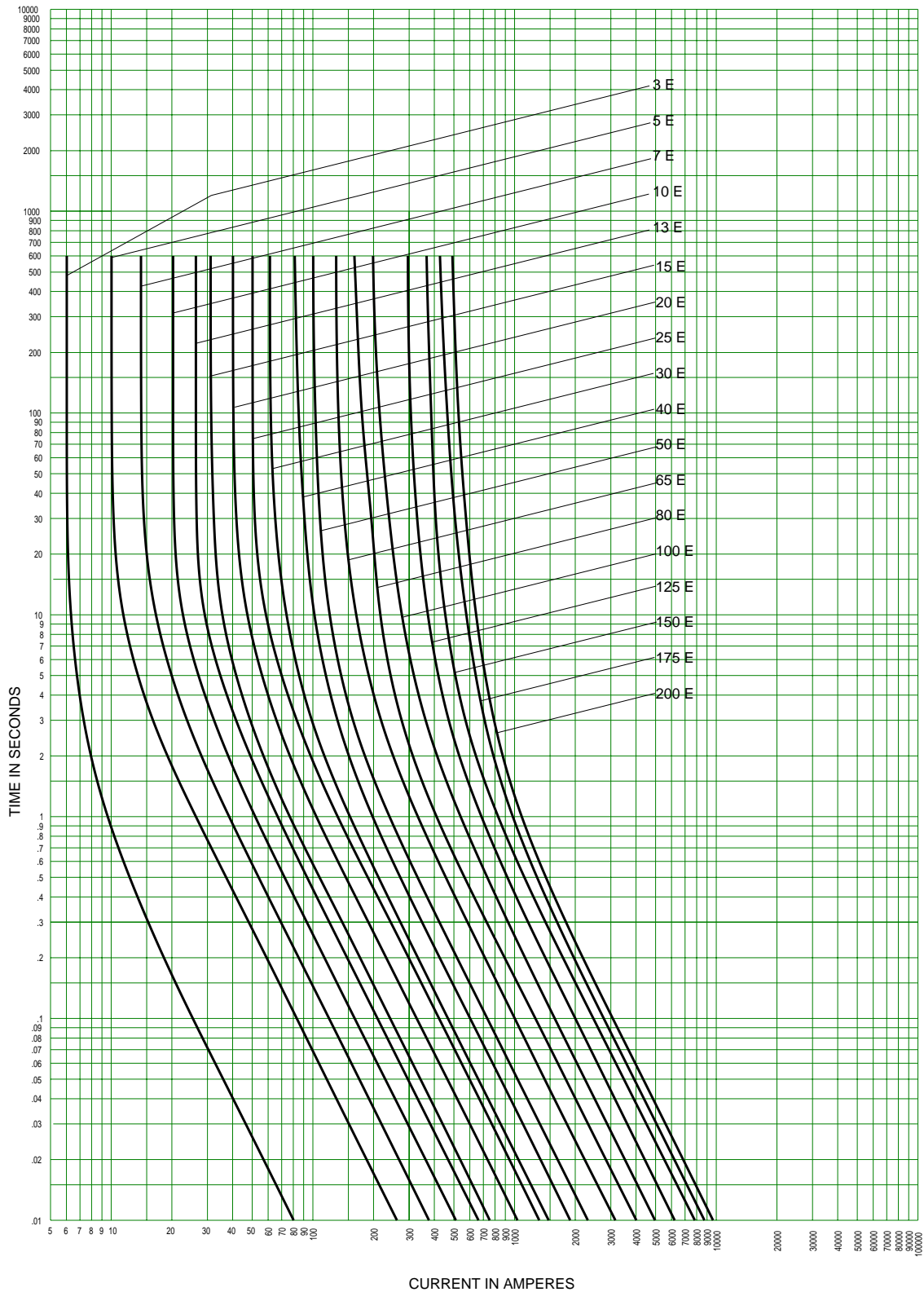

Type DBU Standard E Speed Fuses
 Minimum Melting Time-Current Characteristics - 17.1 - 38 kV

CURVE 36-643 # 11
 July 21, 1999
 Reference # 667027

Curves are based on tests starting with fuse unit at ambient temperature of 25°C and without initial load.
 Curves are plotted to minimum test points so all variations should be positive.

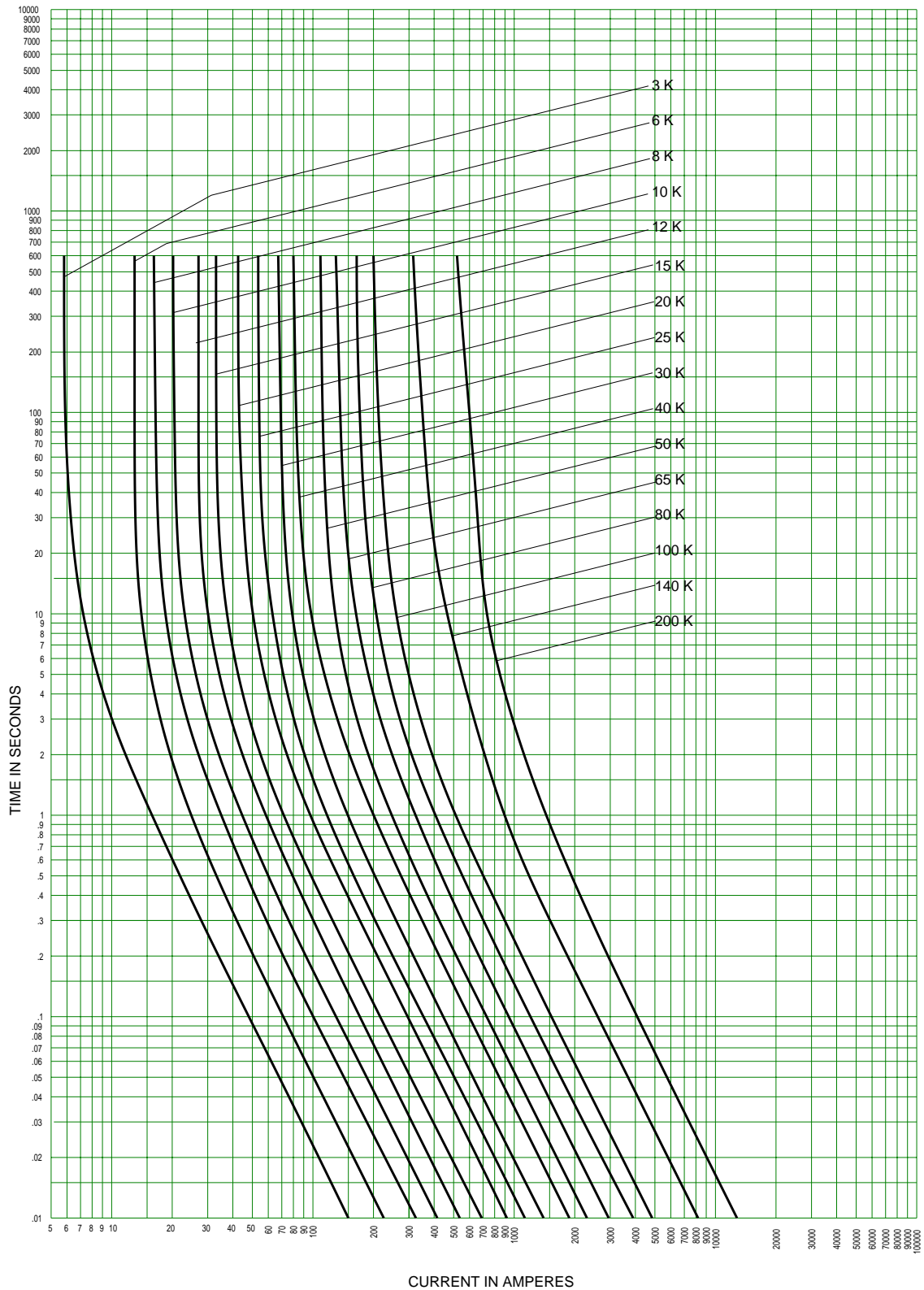

Type DBU Standard K Speed Fuses
Minimum Melting Time-Current Characteristics - 17.1 - 38 kV

CURVE 36-643 # 12
July 21, 1999
Reference # 667028

Curves are based on tests starting with fuse unit at ambient temperature of 25°C and without initial load.
Curves are plotted to minimum test points so all variations should be positive.

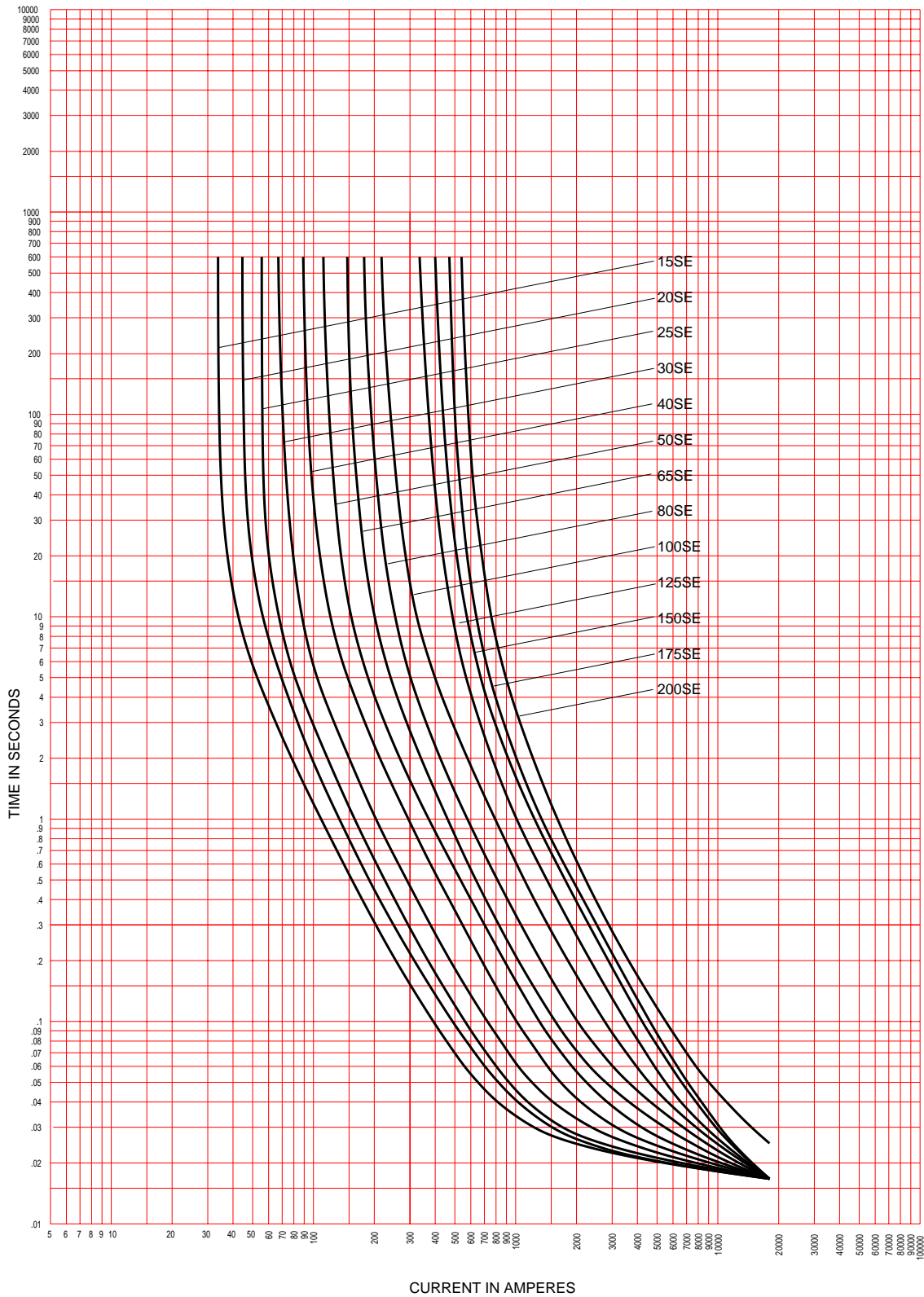

Type DBU Slow E Speed Fuses
Total Clearing Time-Current Characteristics - 17.1 kV

CURVE 36-643 # 13
July 21, 1999
Reference # 667029

Curves are based on tests starting with fuse unit at ambient temperature of 25°C and without initial load.
Curves are plotted to maximum test points so all variations should be negative.

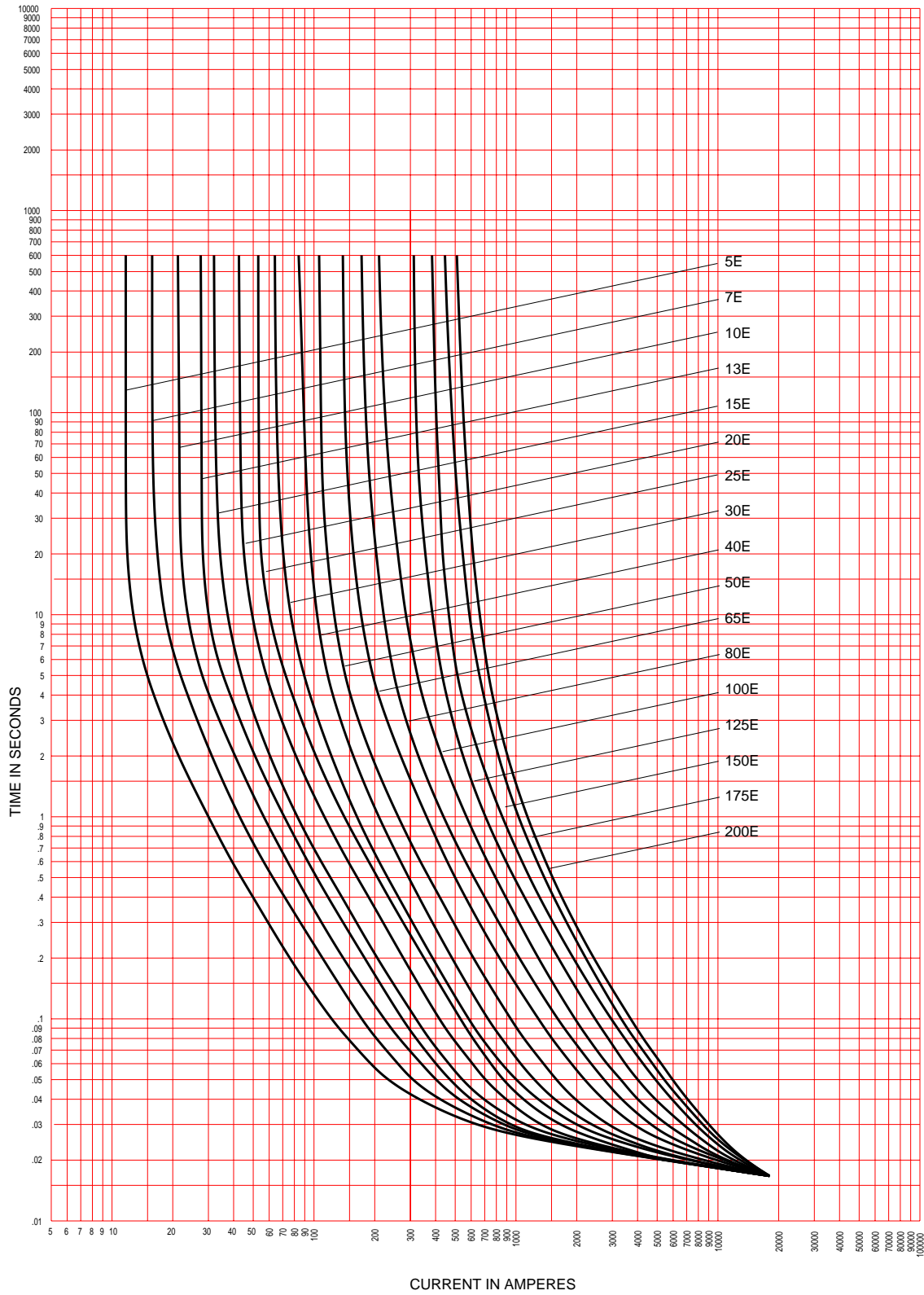

Type DBU Standard E Speed Fuses
Total Clearing Time-Current Characteristics - 17.1 kV

CURVE 36-643 # 14
July 21, 1999
Reference # 667030

Curves are based on tests starting with fuse unit at ambient temperature of 25°C and without initial load.
Curves are plotted to maximum test points so all variations should be negative.

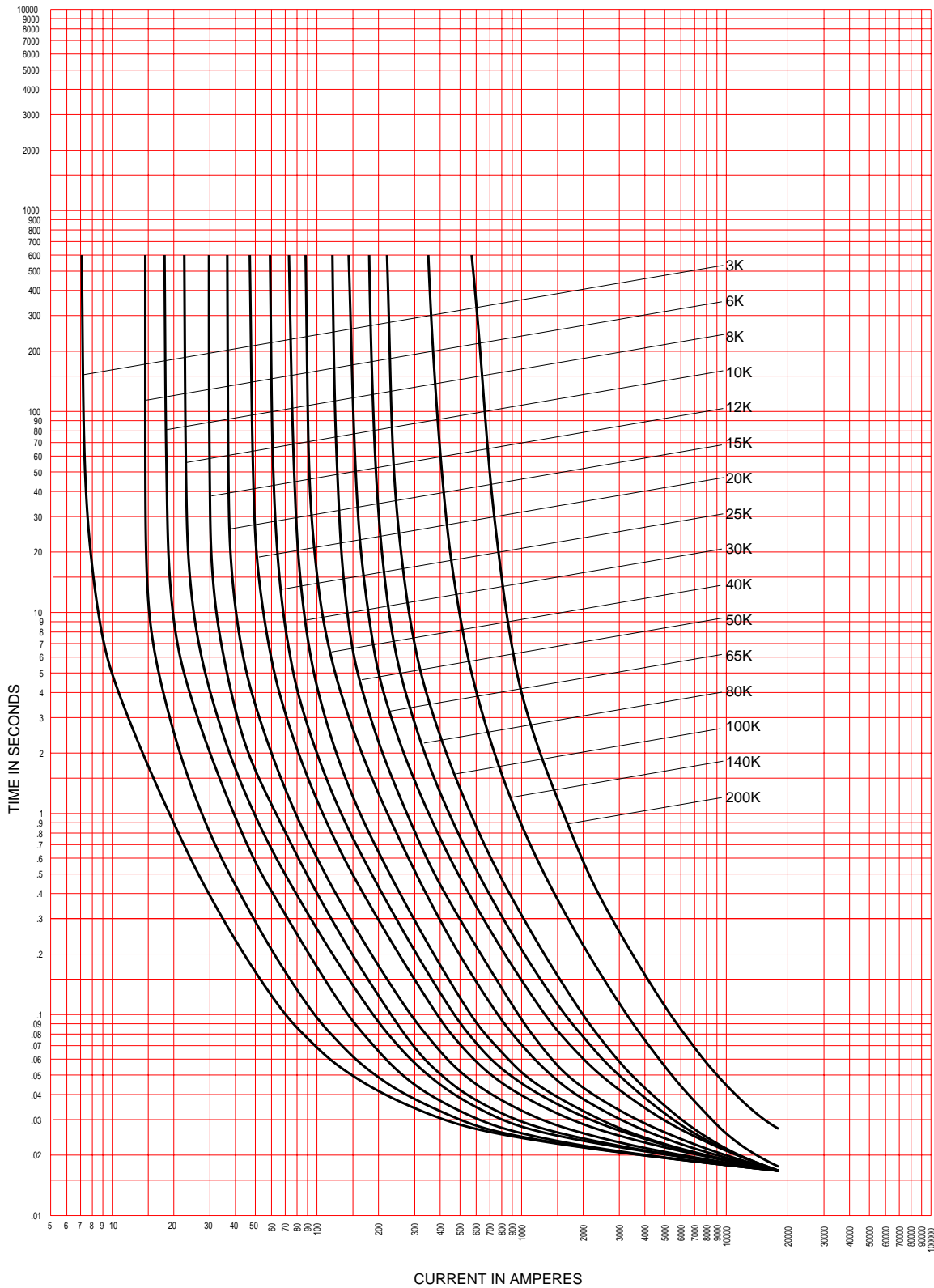

Type DBU Standard K Speed Fuses
Total Clearing Time-Current Characteristics - 17.1 kV

CURVE 36-643 # 15
July 21,
Reference # 667031

Curves are based on tests starting with fuse unit at ambient temperature of 25°C and without initial load.
Curves are plotted to maximum test points so all variations should be negative.

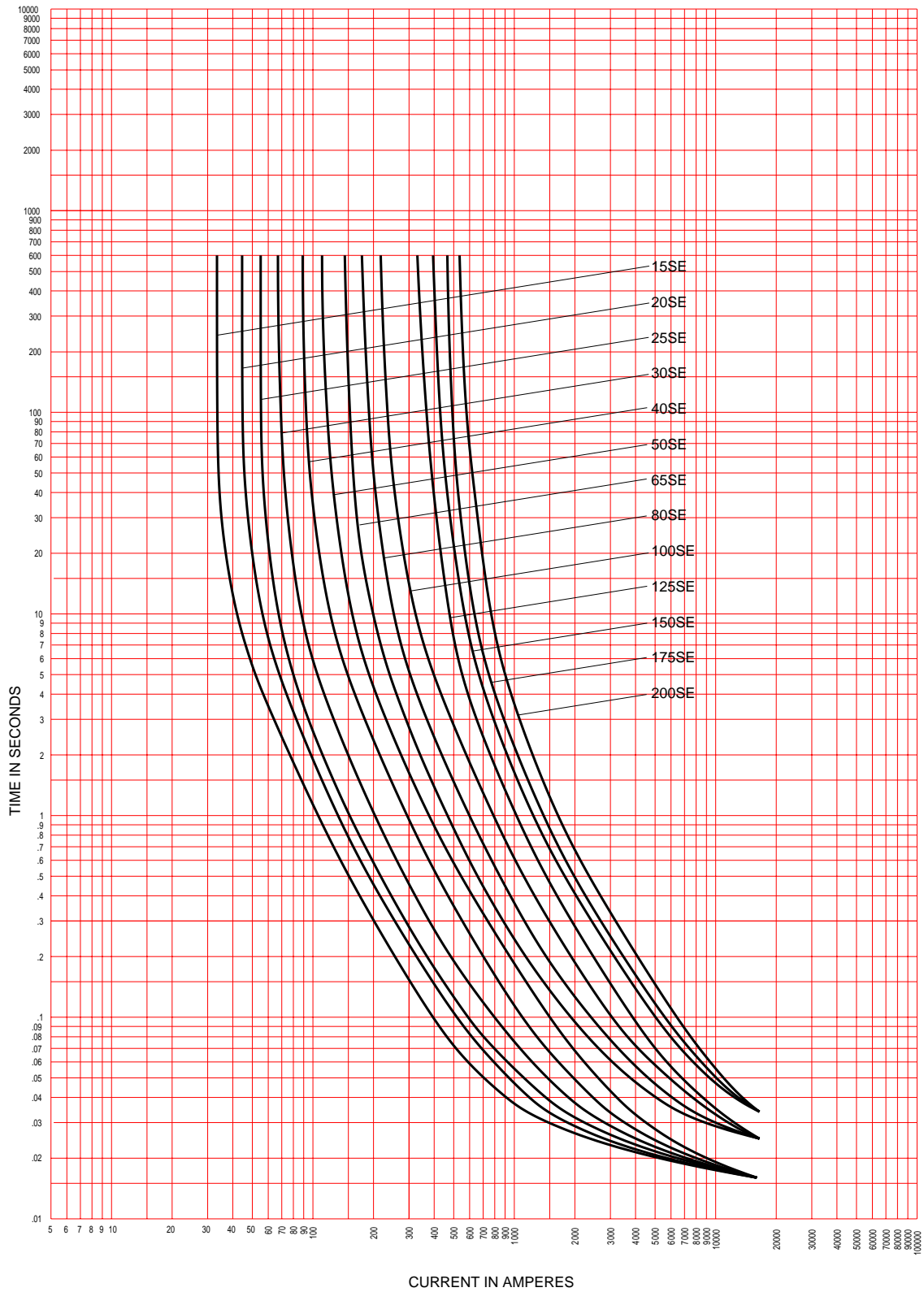

Type DBU Slow E Speed Fuses
Total Clearing Time-Current Characteristics - 27 and 38 kV

CURVE 36-643 # 16
January 5, 2000
Reference # 667038

Curves are based on tests starting with fuse unit at ambient temperature of 25°C and without initial load.
Curves are plotted to maximum test points so all variations should be negative.

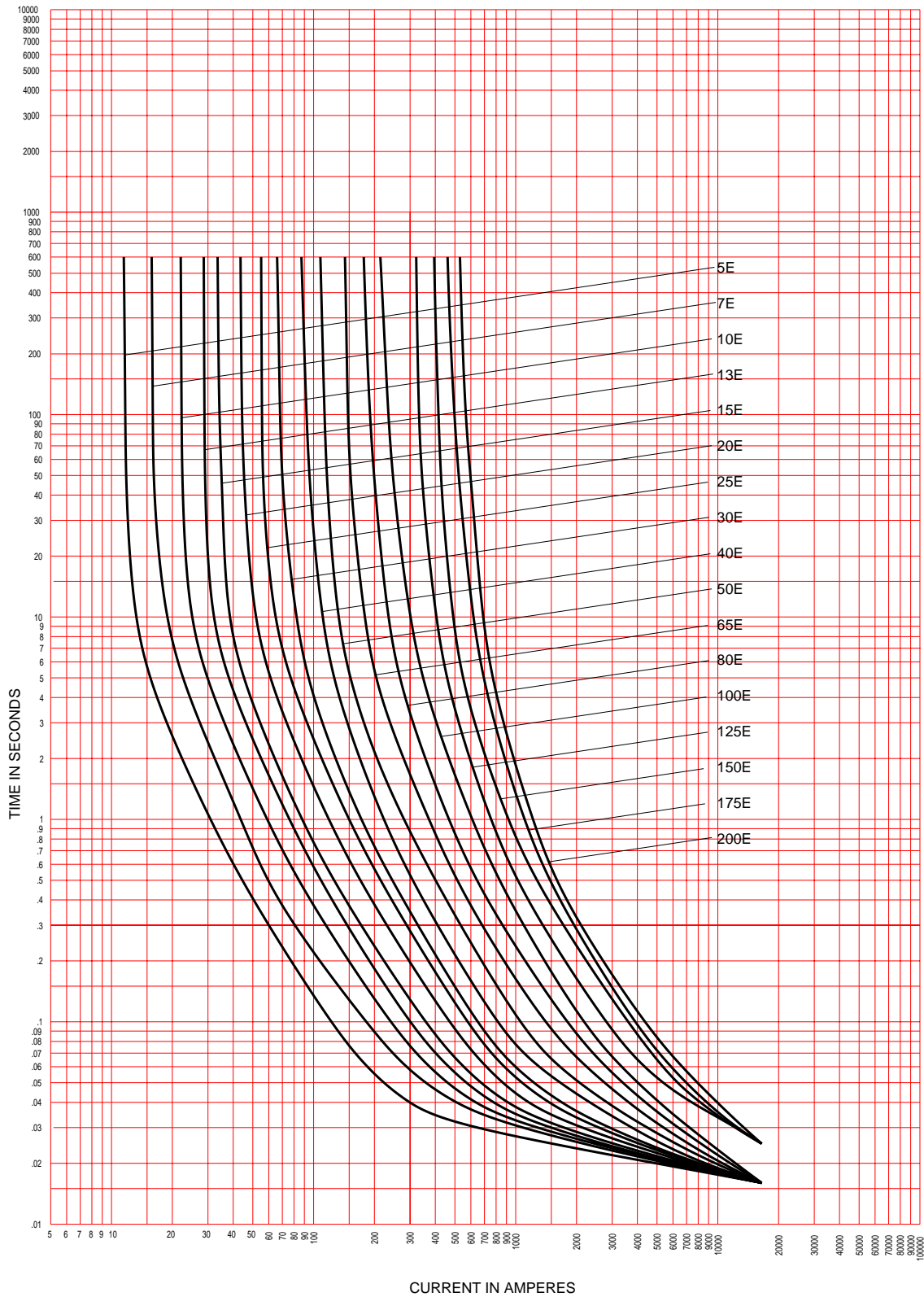

Type DBU Standard E Speed Fuses
 Total Clearing Time-Current Characteristics - 27 and 38 kV

CURVE 36-643 # 17
 January 6, 2000
 Reference # 667039

Curves are based on tests starting with fuse unit at ambient temperature of 25°C and without initial load.
 Curves are plotted to maximum test points so all variations should be negative.

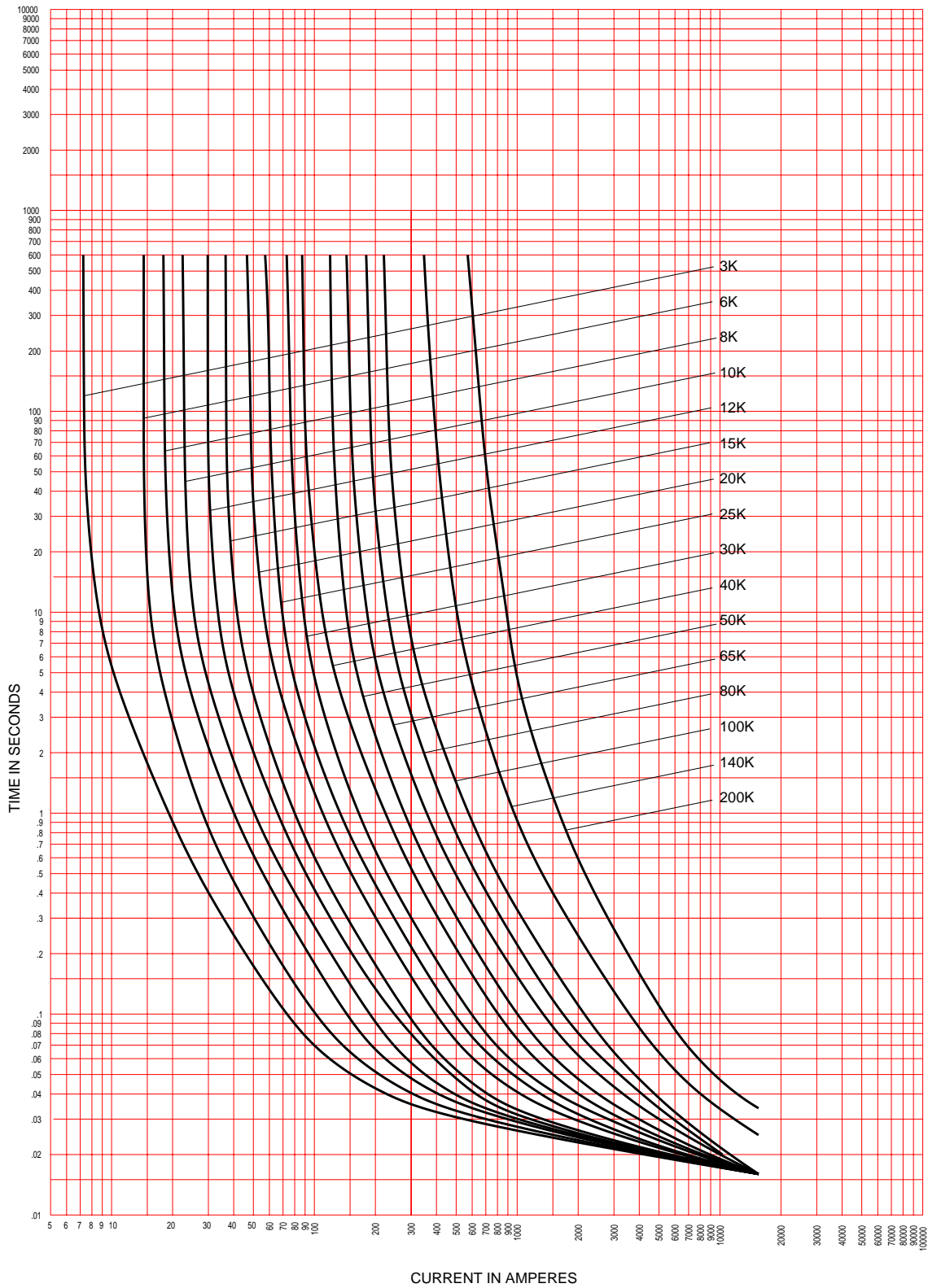

Type DBU Standard K Speed Fuses
Total Clearing Time-Current Characteristics - 27 and 38 kV

CURVE 36-643 # 18
January 6, 2000
Reference # 667040

Curves are based on tests starting with fuse unit at ambient temperature of 25°C and without initial load.
Curves are plotted to maximum test points so all variations should be negative.









Type DBU Expulsion Fuses for Use Indoors or Outdoors

Rating Amperes	Catalog Number	Curve Reference 36-643	Max. Int. kA Sym	Approx. Shipping Wt.	Indoor										Outdoor														
					End Fittings	Catalog Number	Ampere Rating	Disconnect Fuse Mounting	Style	Voltage (kV)			Catalog Number		End Fittings	Catalog Number	Ampere Rating	Fuse Mounting	Style	Voltage (kV)			Catalog Number						
										Nominal	Max	BIL	Mountings (Includes Live Parts)	Live Parts only						Nominal	Max	BIL							
3K 6K 8K 10K 12K 15K 20K 25K 30K 40K 50K 65K 80K 100K 140K 200K	DBU17-3K DBU17-6K DBU17-8K DBU17-10K DBU17-12K DBU17-15K DBU17-20K DBU17-25K DBU17-30K DBU17-40K DBU17-50K DBU17-65K DBU17-80K DBU17-100K DBU17-140K DBU17-200K	12, 15	14	2.1		DBU-EFID	3K to 200K		Non-Loadbreak	14.4	17.0	95	DBU17-GNM	DBU17-NL		DBU-EFOD	3K to 200K												
									Loadbreak	14.4	17.0	95	DBU17-GDM*	DBU17-DL*															
5E 7E 10E 13E 15E 20E 25E 30E 40E 50E 65E 80E 100E 125E 150E 175E 200E	DBU17-5E DBU17-7E DBU17-10E DBU17-13E DBU17-15E DBU17-20E DBU17-25E DBU17-30E DBU17-40E DBU17-50E DBU17-65E DBU17-80E DBU17-100E DBU17-125E DBU17-150E DBU17-175E DBU17-200E	11, 14	14	2.1		DBU-EFID	5E to 200E		Non-Loadbreak	14.4	17.0	95	DBU17-GNM	DBU17-NL		DBU-EFOD	5E to 200E												
									Loadbreak	14.4	17.0	95	DBU17-GDM*	DBU17-DL*															
15E 20E 25E 30E 40E 50E 65E 80E 100E 125E 150E 175E 200E	DBU17-15SE DBU17-20SE DBU17-25SE DBU17-30SE DBU17-40SE DBU17-50SE DBU17-65SE DBU17-80SE DBU17-100SE DBU17-125SE DBU17-150SE DBU17-175SE DBU17-200SE	10, 13	14	2.1		DBU-EFID	15SE to 200SE		Non-Loadbreak	14.4	17	95	DBU17-GNM	DBU17-NL		DBU-EFOD	15SE to 200SE												
									Loadbreak	14.4	17	95	DBU17-GDM*	DBU17-DL*															

Note: Muffler can be ordered separately. Order Catalog number DBU-MFLR.

* To complete the Catalog Number, specify "R" for right side cable termination or "L" for left side cable termination.

Type DBU Expulsion Fuses for Use Indoors or Outdoors

Rating Amperes	Catalog Number	Curve Reference 36-643	Max. Int. KA Sym	Approx. Shipping Wt.	Indoor								Outdoor										
					End Fittings	Catalog Number	Ampere Rating	Disconnect Fuse Mounting	Style	Voltage (kV)			Catalog Number		End Fittings	Catalog Number	Ampere Rating	Fuse Mounting	Style	Voltage (kV)			Catalog Number
										Nominal	Max	BIL	Mountings (Includes Live Parts)	Live Parts only						Nominal	Max	BIL	
3K 6K 8K 10K 12K 15K 20K 25K 30K 40K 50K 65K 80K 100K 140K 200K	DBU27-3K DBU27-6K DBU27-8K DBU27-10K DBU27-12K DBU27-15K DBU27-20K DBU27-25K DBU27-30K DBU27-40K DBU27-50K DBU27-65K DBU27-80K DBU27-100K DBU27-140K DBU27-200K	12, 18	12.5	2.1		DBU-EFID 3K to 200K		Non-Loadbreak Loadbreak	25 25	27.0 27.0	125 125	DBU27-GNM DBU27-GDM*	DBU27-NL DBU27-DL*		DBU-EFOD 3K to 200K								
5E 7E 10E 13E 15E 20E 25E 30E 40E 50E 65E 80E 100E 125E 150E 175E 200E	DBU27-5E DBU27-7E DBU27-10E DBU27-13E DBU27-15E DBU27-20E DBU27-25E DBU27-30E DBU27-40E DBU27-50E DBU27-65E DBU27-80E DBU27-100E DBU27-125E DBU27-150E DBU27-175E DBU27-200E	11, 17	12.5	2.1		DBU-EFID 5E to 200E		Non-Loadbreak Loadbreak	25 25	27.0 27.0	125 125	DBU27-GNM DBU27-GDM*	DBU27-NL DBU27-DL*		DBU-EFOD 5E to 200E								
15E 20E 25E 30E 40E 50E 65E 80E 100E 125E 150E 175E 200E	DBU27-15SE DBU27-20SE DBU27-25SE DBU27-30SE DBU27-40SE DBU27-50SE DBU27-65SE DBU27-80SE DBU27-100SE DBU27-125SE DBU27-150SE DBU27-175SE DBU27-200SE	10, 16	12.5	2.1		DBU-EFID 15SE to 200SE		Non-Loadbreak Loadbreak	25 25	27.0 27.0	125 125	DBU27-GNM DBU27-GDM*	DBU27-NL DBU27-DL*		DBU-EFOD 15SE to 200SE								

Note: Muffler can be ordered separately. Order Catalog number DBU-MFLR.

* To complete the Catalog Number, specify "R" for right side cable termination or "L" for left side cable termination.

Type DBU Expulsion Fuses for Use Indoors or Outdoors

Rating Amperes	Catalog Number	Curve Reference 36-643	Max. Int. kA Sym	Approx. Shipping Wt.	Indoor							Outdoor													
					End Fittings	Catalog Number	Ampere Rating	Disconnect Fuse Mounting	Style	Voltage (kV)			Catalog Number		End Fittings	Catalog Number	Ampere Rating	Fuse Mounting	Style	Voltage (kV)			Catalog Number		
										Nominal	Max	BIL	Mountings (Includes Live Parts)	Live Parts only						Nominal	Max	BIL			
3K 6K 8K 10K 12K 15K 20K 30K 40K 50K 65K 80K 100K 140K 200K	DBU38-3K DBU38-6K DBU38-8K DBU38-10K DBU38-12K DBU38-15K DBU38-20K DBU38-30K DBU38-40K DBU38-50K DBU38-65K DBU38-80K DBU38-100K DBU38-140K DBU38-200K	12, 18	10	2.8		DBU-EFID 3K to 200K		Non-Loadbreak	34.5	38.0	150	DBU38-GNM	DBU38-NL		DBU-EFOD 3K to 200K										
5E 7E 10E 13E 15E 20E 25E 30E 40E 50E 65E 80E 100E 125E 150E 175E 200E	DBU38-5E DBU38-7E DBU38-10E DBU38-13E DBU38-15E DBU38-20E DBU38-25E DBU38-30E DBU38-40E DBU38-50E DBU38-65E DBU38-80E DBU38-100E DBU38-125E DBU38-150E DBU38-175E DBU38-200E	11, 17	10	2.8		DBU-EFID 5E to 200E		Non-Loadbreak	34.5	38.0	150	DBU38-GNM	DBU38-NL		DBU-EFOD 5E to 200E										
15E 20E 25E 30E 40E 50E 65E 80E 100E 125E 150E 175E 200E	DBU38-15SE DBU38-20SE DBU38-25SE DBU38-30SE DBU38-40SE DBU38-50SE DBU38-65SE DBU38-80SE DBU38-100SE DBU38-125SE DBU38-150SE DBU38-175SE DBU38-200SE	10, 16	10	2.8		DBU-EFID 15SE to 200SE		Non-Loadbreak	34.5	38.0	150	DBU38-GNM	DBU38-NL		DBU-EFOD 15SE to 200SE										

*Note: Muffler can be ordered separately. Order Catalog number DBU-MFLR.



DBA Fuses

The Type DBA (dropout, boric acid) high voltage expulsion fuse is an E-rated, vented device designed for power applications.

Introduction

The DBA Power Fuse provides double protection for circuits and equipment which operate on voltages from 7.2 to 145 kV. The fuse has instant acting De-ion circuit interruption and almost simultaneously, a mechanical dropout action gives a 180° air break. The fuse unit is of the replaceable type rather than the renewable type, resulting in light weight for ease in handling.

Construction

De-ion arc interruption permits application of the Type DBA power fuse over a wide range of system voltages. This line of dropout fuses carries the boric acid principle of circuit protection to higher voltage ratings, and at the same time provides at lower cost short circuit protection for systems of moderate capacity.

Principle parts of the DBA fuse unit are shown in the cross section Figure 12. Main operating parts are the fusible element, arcing rod, helical spring, and dry boric acid cylinder. To prevent warping under outdoor conditions, a heavy Micarta tube encloses the entire assembly. This Micarta tube also assures adequate strength to contain the force of the arc interruption.

Within the fuse unit, the current path is maintained by tight electrical connections. From the top ferrule, the path is to the copper tube spring shunt; then to the arcing rod collar and the arcing rod, on through the fusible element which is bridged by the strain element, and into the bottom ferrule. The copper spring shunt and the arcing rod collar are firmly held together by the contact finger

spring. When the fuse element is blown, the arcing rod is pulled upward drawing the arc into the boric acid cylinder. The spring shunt contact fingers close in on the rod to maintain the electrical path. Intense heat from the arc, as it strikes, decomposes the compressed boric acid powder.

Decomposition of the dry boric acid

forms water vapor and inert boric acid. The electrical interruption is caused by the steam de-ionizing the arc as it is drawn through the cylinder by action of the spring and rod.

The arcing rod is prevented from falling back into the fuse until after interruption by a friction stop as shown just inside the top ferrule.

DBA fuses are available as replacement fuse units only for existing applications.

Figure 12: DBA Fuse Construction

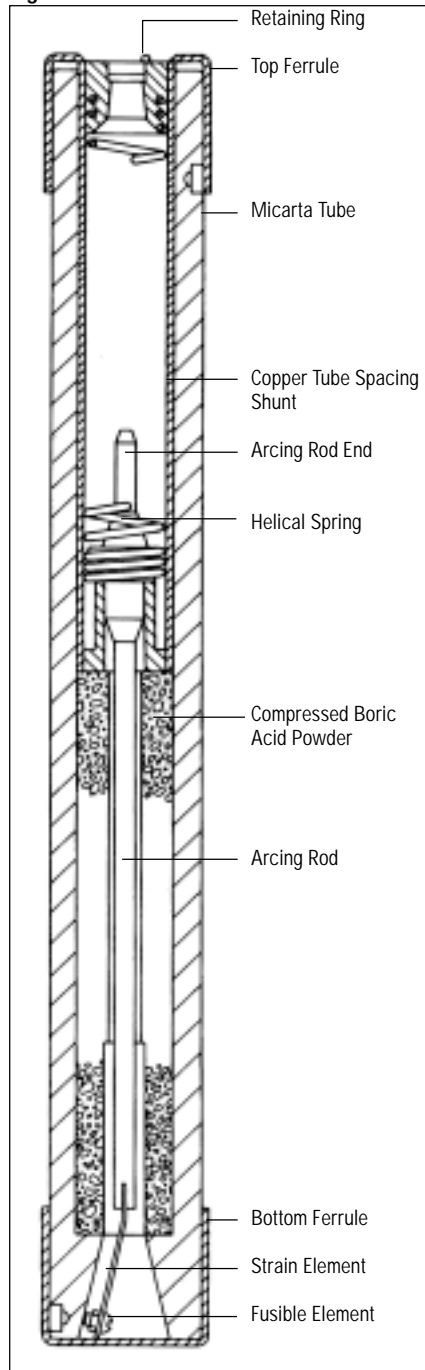

Type DBA-1
7.2 to 69 kV
1/2E to 200E Amps

Nom. Fuse Voltage	Fuse Dim. Inches T	Approx. Wt. lbs.
7.2	13 1/2	2
15.0	17	3
23.0	21 1/2	4
34.5	28 1/2	5
46.0	34	6
69.0	43 7/8	7

Type DBA-2
92 to 138 kV
1/2E to 200E Amps

Nom. Fuse Voltage	Fuse Dim. Inches T	Approx. Wt. lbs.
92	52	19
115	62	22
138	72	25

Operation

The DBA type fuse unit is of the replaceable type rather than the renewable type. When fuse is blown and drop-out completed, the entire unit is removed with a hookstick. After replacement of the blown unit, it is closed back into place with the hookstick.

In replacing the blown fuse, the end fittings are removed and clamped on a new fuse. End fittings consist of an operating eye at the top and hinge lifting eye at the bottom. The two fittings have different shapes and are keyed with different projections. Fittings are simple to remove or replace, and cannot be reversed since the keys insure quick, correct alignment.

De-ion circuit interruption by action of the boric acid fuse unit is followed simultaneously by a mechanical drop-out action. When closing the fuse unit with the hookstick, the ejector casting located under the sleet hood, compresses the ejector spring. Under fault conditions the fuse element melts, the helical spring pulls the arcing rod and arc through the cylinder. The upper end of the arcing rod drives through a small hole in the top of the ferrule of the fuse unit and strikes the trigger-releasing ejector. The trigger operates and causes the ejector spring to force the ejector casting against the fuse assembly forcing it outward to swing through a 180° arc into a drop-out position. Drop-out action provides immediate visual indication that the particular circuit in which the fuse is connected has been interrupted. The additional drop-out break insulates the fault from the feeders with an air gap of at least 1 foot on lower voltage system and up to 6 feet on higher voltage systems.

This air break eliminates any possibility of carbonized fuse parts breaking down to allow leakage or another fault. Since drop-out action takes place after current interruption within the boric acid cylinder, burning or arcing at the contact surfaces is eliminated.

Application

The DBA fuse is applicable in utility and industrial high voltage power systems for protecting:

- Power transformers
- Feeder circuit sectionalizing
- Distribution transformers
- Potential transformers

Maximum Design Voltage (kV)	Type DBA-1	Type DBA-2
	Interrupting Ratings Rms Amps (Sym.)	Interrupting Ratings Rms Amps (Sym.)
8.3	6300	...
15.5	6300	...
25.5	6300	...
38.0	5000	12,500
48.3	4000	12,500
72.5	2500	10,000
92.0	...	6,300
121	...	5,000
145	...	4,000

Ratings

- 8.3 to 145 kV
- .5E to 200E Amperes

The Power Fuse is an inherently fast circuit-interrupting device. This must be taken into account when determining the required short circuit interrupting rating of a fuse.

The boric acid power fuse will interrupt currents of short circuit magnitude in approximately 1/2 cycle measured from the instant of short circuit. During this 1/2 cycle, the short circuit current may be much higher than the sustained rms short circuit current of the system at that point. The fuse must be capable of safely interrupting this transient current which might exist at the instant the fuse operates.

In an alternating current circuit containing inductance, a sudden change in the AC current is accompanied by a transient DC component which is a function of the AC current before and after the change and the point on the cycle at which the change occurs. The decrement of the transient is a function of the inductance and resistance or losses of the circuit.

If a short is suddenly established on a circuit, the DC component can have a maximum peak value equal to the crest of the 60 cycle short circuit current of the system. This maximum transient is obtained if the fault occurs at voltage zero. Due to the system losses, this DC component will die out to a low value in a few cycles. However, a fuse normally interrupts a short circuit in 1/2 cycle, and this DC component of current must be taken into consideration in rating the fuse. If the decrement of DC component in this half cycle is neglected, the rms value of current for the totally asymmetrical condition would be 1.73 times the rms symmetrical value of the 60 cycle component.

Experience has shown that there is some decrement in this first half cycle and also that the current is limited somewhat by the arc drop in the fuse. For this reason, a ratio of 1.6 has been selected between the rms asymmetrical current the fuse must be designed to interrupt, and the rms short circuit of the system on which the fuse is to be used. This instantaneous rms asymmetrical value of short circuit current, which the fuse must be designed to interrupt, is often referred to as the rms symmetrical value including the DC component. The asymmetrical value is obtained by multiplying the symmetrical value by 1.6. The symmetrical value of short circuit current on a 3 phase system is determined by dividing the available 3 phase, short circuit kVA by the product of the system voltage and $\sqrt{3}$.

Instructions for Type DBA Fuse Units 8.3 kV to 145 kV

Installation of Replacement Fuses

DBA Fuse units are available in two classifications, DBA-1 and DBA-2 and are used for utility-type applications from 8.3 kV through 145 kV.

Remove fuses from all three phases and replace with new or tested units. Fuses having been involved in a fault but not blown should be tested by resistance measurements to ascertain that they are suitable for continued service. Resistance limits are available on request.

Prior to installation, it is advisable to check the functioning of the mounting as follows:

1. Remove fuse fittings from hinge casting (Fig. 15) and mount on a suitable fuse unit as shown in Fig. 13.
2. Check gauging distance "S" between center of guide pin in latch housing and bottom of socket in hinge casting as illustrated in Fig. 14. Dimension "S" must measure the same on both sides of the mounting. If dimension "S" is found to be incorrect, adjust it by utilizing the clearances provided in the bolt

holes (Fig. 16).

3. Put the suitable fuse unit equipped with fittings in the mounting. Check operation of latch assembly by closing and opening the fuse as shown in Fig. 17.

DBA-1 fuses up to 69 kV as well as DBA-2 fuses up to 46 kV can be lifted into the hinge casting by means of conventional all-purpose hooksticks. For lifting heavier fuses into the hinge, a hookstick about one foot shorter than the distance from ground level to the fuse hinge is recommended. This hookstick should be held approximately vertical as shown in Fig. 17. For the closing-in or disconnecting operation, a hookstick of at least four foot greater length should be employed. Insert the hookstick pin into the eye of the fuse fitting from the right-hand side and have it form an angle of at least 35° with the fuse.

Fuse should be closed in with a sharp thrust. A similar impact-like pull is required to open the fuse. After the latch contacts have parted, the fuse may be allowed to disengage itself from the hookstick and drop out in a normal manner.

Maintenance

General maintenance instructions are published in the IEEE Standard C-37.48-1973. Inspection of the fuse mounting should include checking the gauge distance "S" (Fig. 14) and the operation of the latch mechanism.

Figure 13: Fuse Unit with Fittings

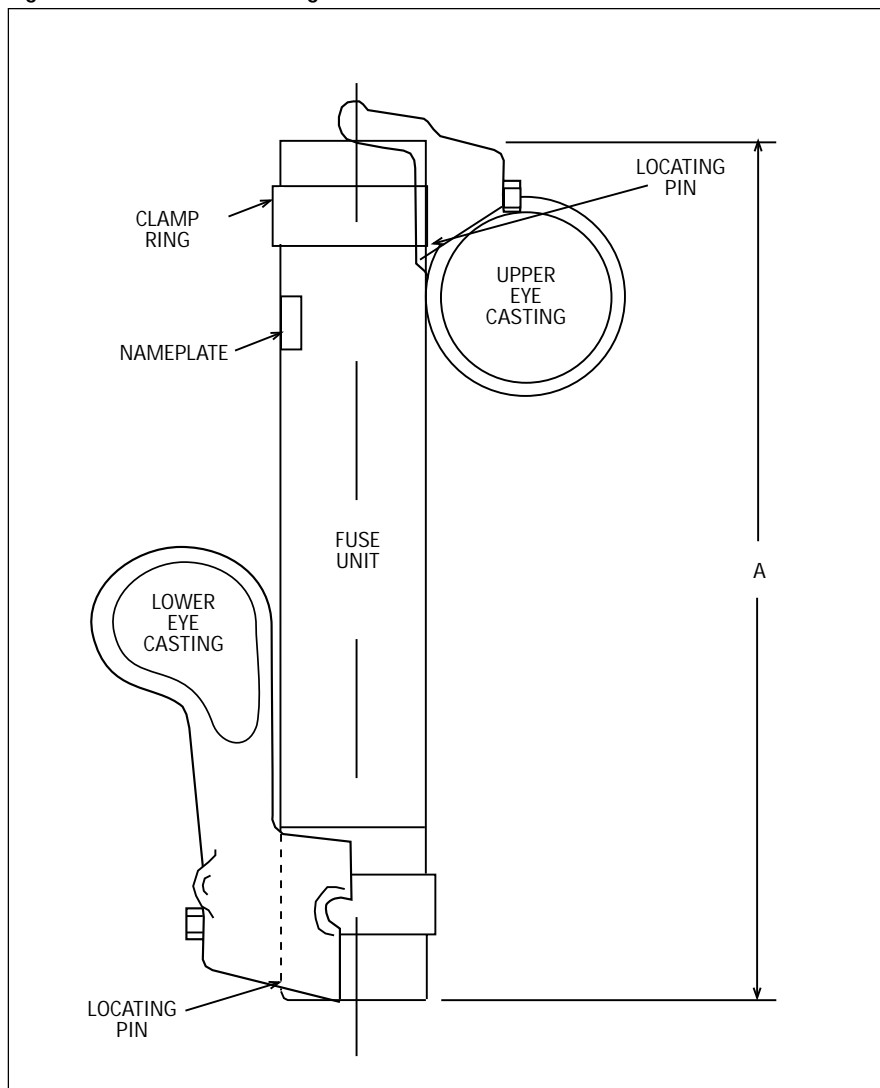

kV	DBA-1	DBA-2
7.2	13.5	...
15	17	...
23	21.5	...
34.5	28.5	28.13
46	34	33.63
69	43.88	43.63
92	...	52
115	...	62
138	...	72

Figure 14: Insulator Spacing

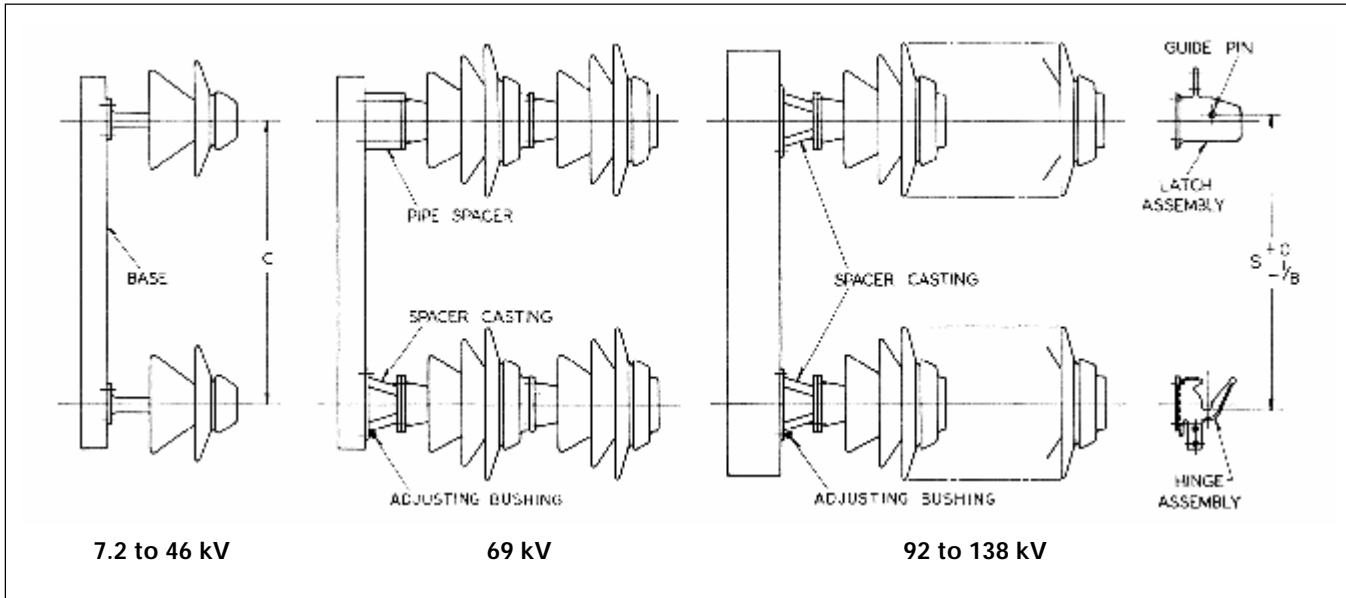

Type	Dimensions	Voltage Rating (K.V.)									
		7.2	15	23	34.5	46	69	92	115	138	
DBA-1	C	13.63	17.13	21.63	28.63	34.13	44	—	—	—	
	S	15.25	18.75	23.25	30.25	35.75	45.63	—	—	—	
DBA-2	C	—	—	—	27.88	33.38	43.38	51.75	61.75	71.75	

Figure 15: Hinge Assembly

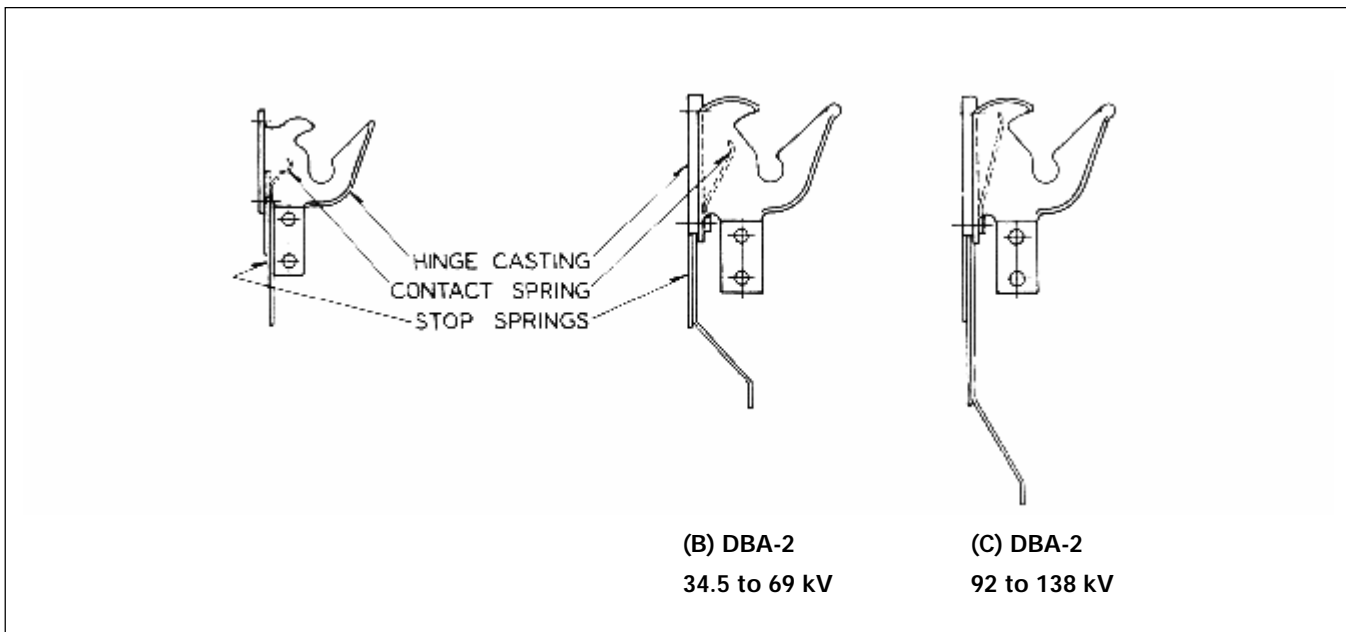

Figure 16: Spacer Adjustment

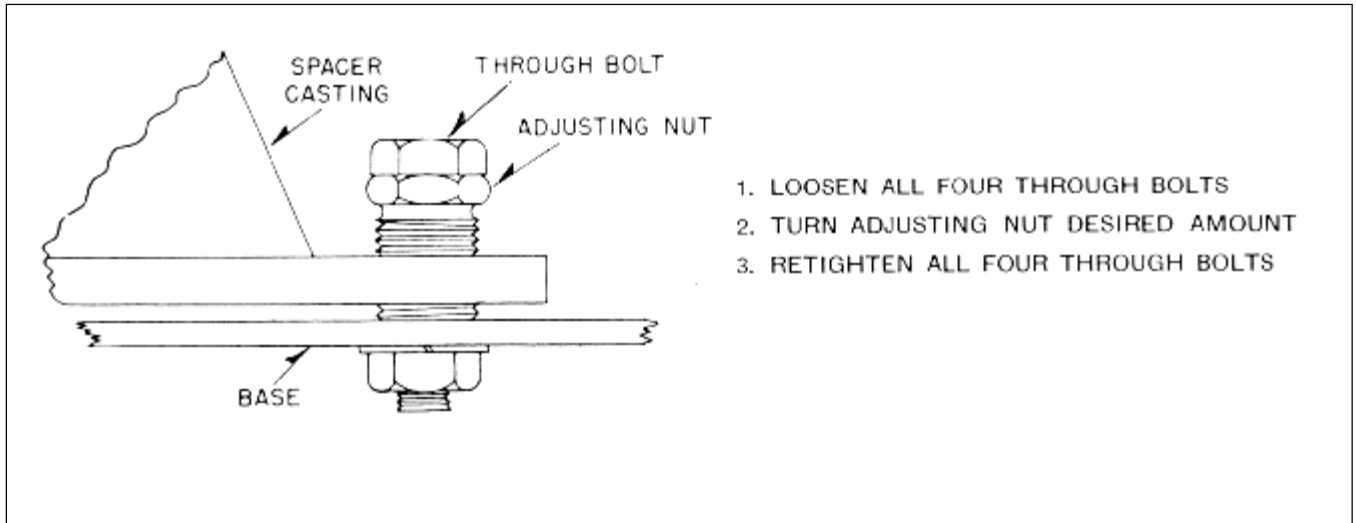
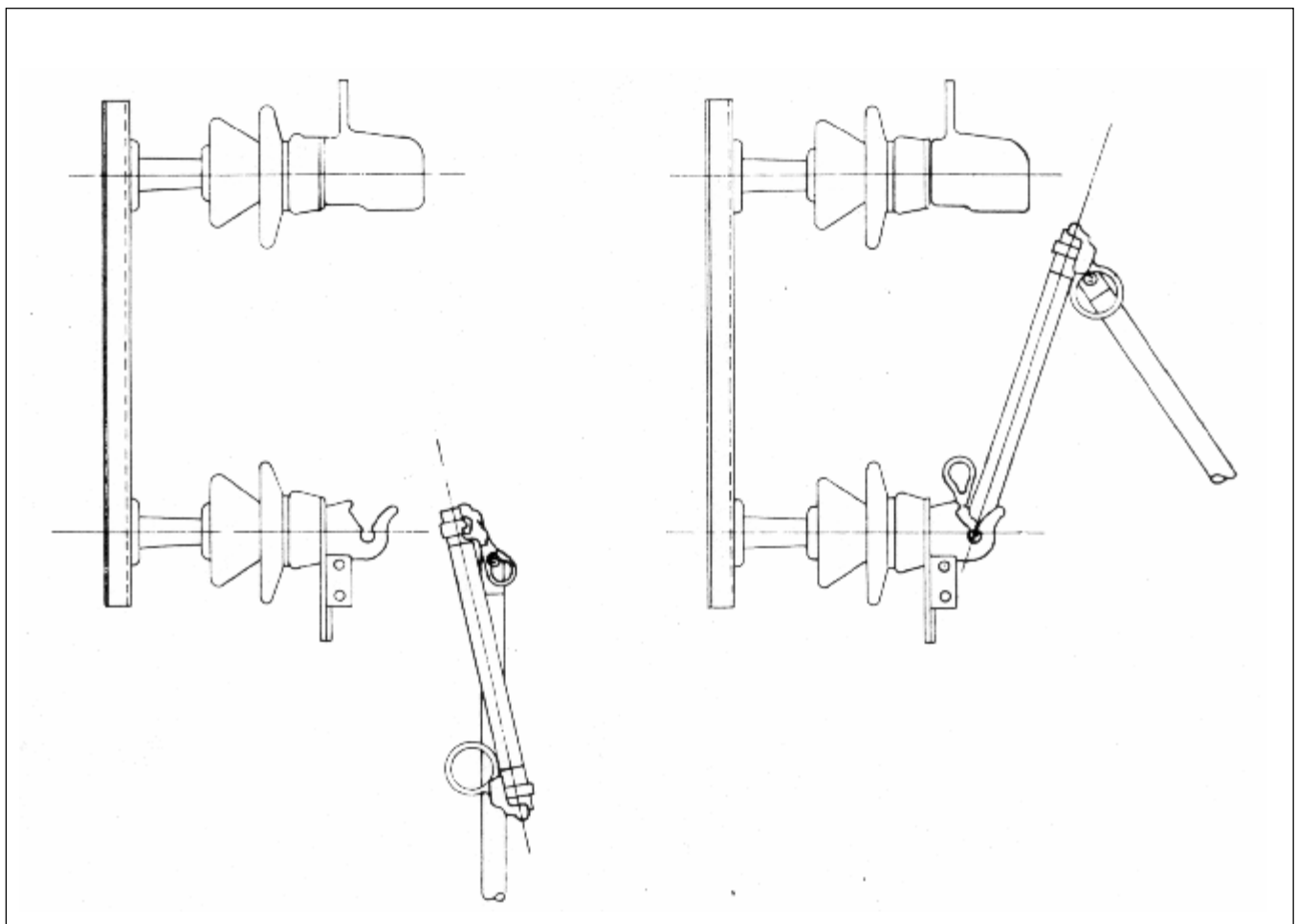
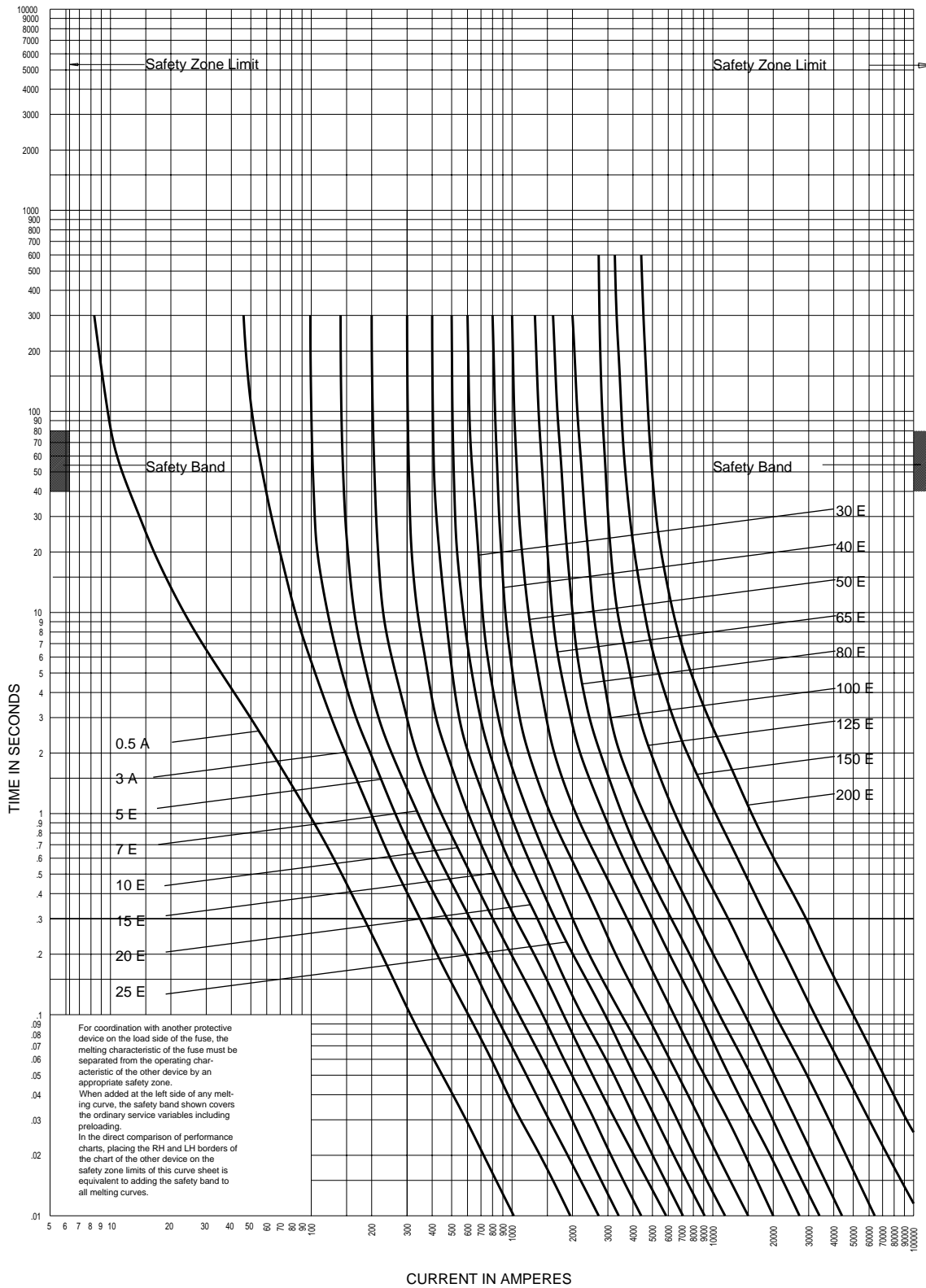

Figure 17: Hookstick Operation





Type DBA-1 and -2 Dropout Power - Standard Speed Fuse Elements
Minimum Melting Time-Current Characteristics

CURVE 36-623 # 10
July 2000
Reference # 459351

Curves are based on tests starting with fuse unit at ambient temperature of 25°C and without initial load.
Curves are plotted to minimum test points so all variations should be positive.

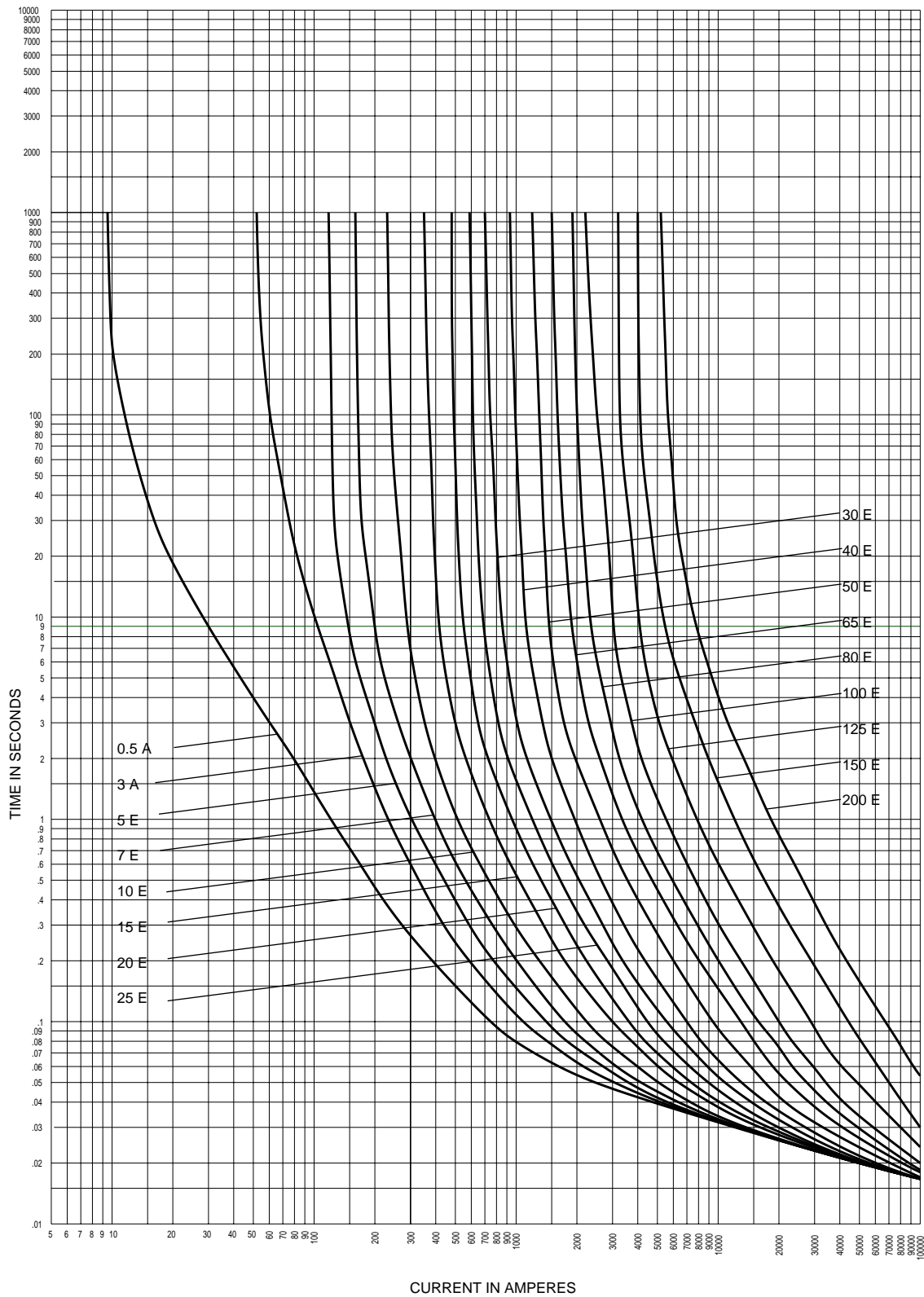

Type DBA-1 Dropout Power - Standard Speed Fuse Elements
 Total Clearing Time-Current Characteristics - 2.4 to 23 kV

CURVE 36-623 # 11
 July 2000
 Reference # 459352

Curves are based on tests starting with fuse unit at ambient temperature of 25°C and without initial load.
 Curves are plotted to maximum test points so all variations should be negative.

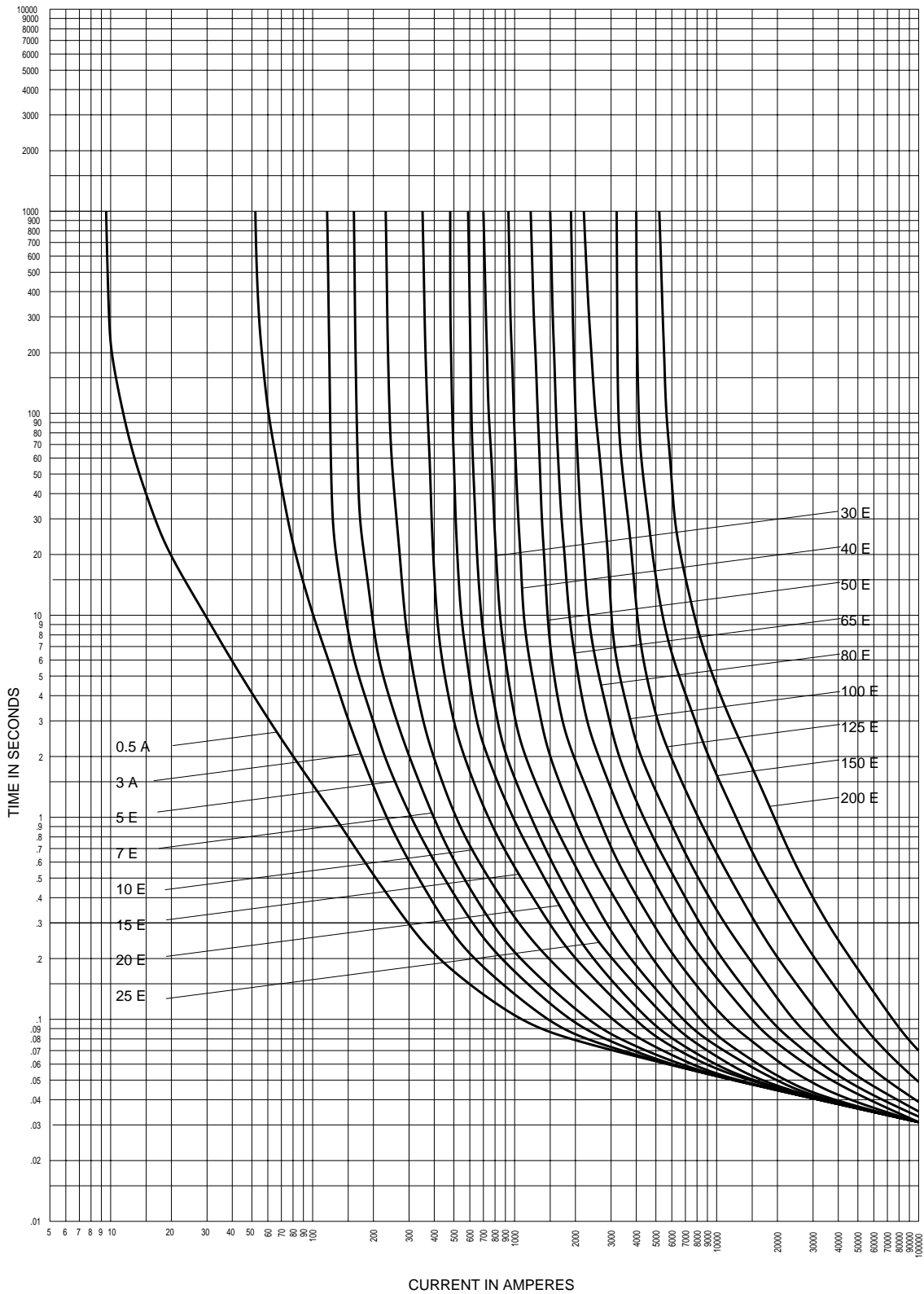

Type DBA-1 and -2 Dropout Power - Standard Speed Fuse Elements
 Total Clearing Time-Current Characteristics - 34.5 to 69 kV

CURVE 36-623 # 12
 July 2000
 Reference # 459353

Curves are based on tests starting with fuse unit at ambient temperature of 25°C and without initial load.
 Curves are plotted to maximum test points so all variations should be negative.

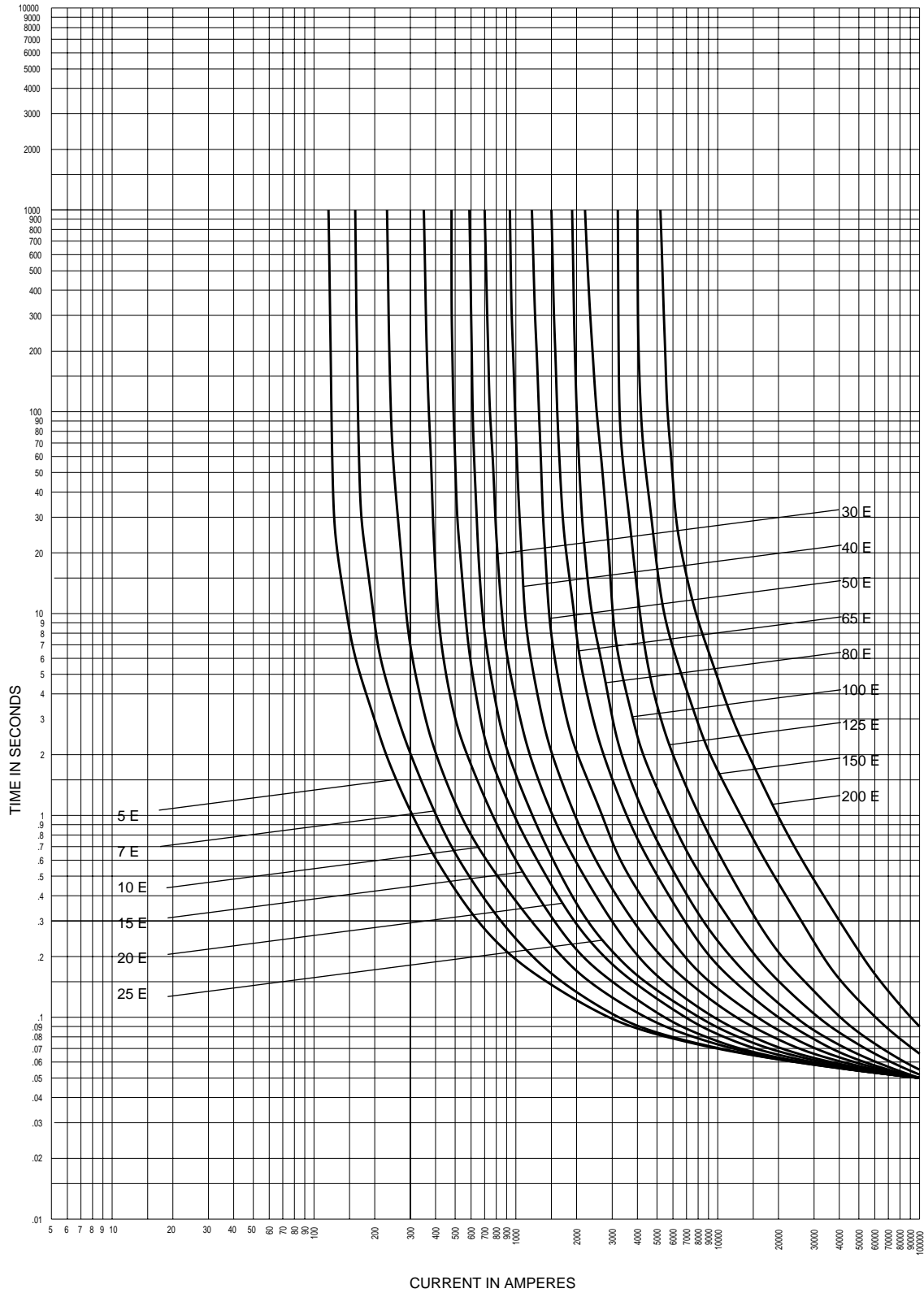

Type DBA- -2 Dropout Power - Standard Speed Fuse Elements
 Total Clearing Time-Current Characteristics - 92 to 138 kV

CURVE 36-623 # 13
 July 2000
 Reference # 459354

Curves are based on tests starting with fuse unit at ambient temperature of 25°C and without initial load.
 Curves are plotted to maximum test points so all variations should be negative.

Type DBA Expulsion Fuses for Use Indoors or Outdoors

Rating Amperes	DBA - 1 Fuse Units		Approximate Shipping Weight
	Catalog Number	Curve Reference 36-623	
Type DBA-1 Fuse Refills			
8.3 kV Max (7.2 kV Nominal)			
0.5E	8DBA1-.5E	(10, 11)	2.1
3E	8DBA1-3E		
5E	8DBA1-5E		
7E	8DBA1-7E		
10E	8DBA1-10E		
15E	8DBA1-15E		
20E	8DBA1-20E		
25E	8DBA1-25E		
30E	8DBA1-30E		
40E	8DBA1-40E		
50E	8DBA1-50E		
65E	8DBA1-65E		
80E	8DBA1-80E		
100E	8DBA1-100E		
125E	8DBA1-125E		
150E	8DBA1-150E		
200E	8DBA1-200E		
15.5 kV Max (14.4 kV Nominal)			
0.5E	15DBA1-.5E	(10, 11)	2.1
3E	15DBA1-3E		
5E	15DBA1-5E		
7E	15DBA1-7E		
10E	15DBA1-10E		
15E	15DBA1-15E		
20E	15DBA1-20E		
25E	15DBA1-25E		
30E	15DBA1-30E		
40E	15DBA1-40E		
50E	15DBA1-50E		
65E	15DBA1-65E		
80E	15DBA1-80E		
100E	15DBA1-100E		
125E	15DBA1-125E		
150E	15DBA1-150E		
200E	15DBA1-200E		
25 kV Max (23 kV Nominal)			
0.5E	25DBA1-.5E	(10, 11)	3.1
3E	25DBA1-3E		
5E	25DBA1-5E		
7E	25DBA1-7E		
10E	25DBA1-10E		
15E	25DBA1-15E		
20E	25DBA1-20E		
25E	25DBA1-25E		
30E	25DBA1-30E		
40E	25DBA1-40E		
50E	25DBA1-50E		
65E	25DBA1-65E		
80E	25DBA1-80E		
100E	25DBA1-100E		
125E	25DBA1-125E		
150E	25DBA1-150E		
200E	25DBA1-200E		
Type DBA-1 Fuse Refills			
38 kV Max (34.5 kV Nominal)			
0.5E	38DBA1-.5E	(10, 12)	4.2
3E	38DBA1-3E		
5E	38DBA1-5E		
7E	38DBA1-7E		
10E	38DBA1-10E		
15E	38DBA1-15E		
20E	38DBA1-20E		
25E	38DBA1-25E		
30E	38DBA1-30E		
40E	38DBA1-40E		
50E	38DBA1-50E		
65E	38DBA1-65E		
80E	38DBA1-80E		
100E	38DBA1-100E		
125E	38DBA1-125E		
150E	38DBA1-150E		
200E	38DBA1-200E		
48 kV Max (46 kV Nominal)			
0.5E	48DBA1-.5E	(10, 12)	6.5
3E	48DBA1-3E		
5E	48DBA1-5E		
7E	48DBA1-7E		
10E	48DBA1-10E		
15E	48DBA1-15E		
20E	48DBA1-20E		
25E	48DBA1-25E		
30E	48DBA1-30E		
40E	48DBA1-40E		
50E	48DBA1-50E		
65E	48DBA1-65E		
80E	48DBA1-80E		
100E	48DBA1-100E		
125E	48DBA1-125E		
150E	48DBA1-150E		
200E	48DBA1-200E		
72 kV Max (69 kV Nominal)			
0.5E	72DBA1-.5E	(10, 12)	7.1
3E	72DBA1-3E		
5E	72DBA1-5E		
7E	72DBA1-7E		
10E	72DBA1-10E		
15E	72DBA1-15E		
20E	72DBA1-20E		
25E	72DBA1-25E		
30E	72DBA1-30E		
40E	72DBA1-40E		
50E	72DBA1-50E		
65E	72DBA1-65E		
80E	72DBA1-80E		
100E	72DBA1-100E		
125E	72DBA1-125E		
150E	72DBA1-150E		
200E	72DBA1-200E		

Type DBA Expulsion Fuses for Use Indoors or Outdoors

Rating Amperes	DBA - 2 Fuse Units		Approximate Shipping Weight
	Catalog Number	Curve Reference 36-623	
Type DBA-2 Fuse Refills			
38 kV Max (34.5 kV Nominal)			
0.5E	38DBA2-5E	(10,12)	8.0
3E	38DBA2-3E		
5E	38DBA2-5E		
7E	38DBA2-7E		
10E	38DBA2-10E		
15E	38DBA2-15E		
20E	38DBA2-20E		
25E	38DBA2-25E		
30E	38DBA2-30E		
40E	38DBA2-40E		
50E	38DBA2-50E		
65E	38DBA2-65E		
80E	38DBA2-80E		
100E	38DBA2-100E		
125E	38DBA2-125E		
150E	38DBA2-150E		
200E	38DBA2-200E		
48 kV Max (46 kV Nominal)			
0.5E	48DBA2-5E	(10, 12)	8.0
3E	48DBA2-3E		
5E	48DBA2-5E		
7E	48DBA2-7E		
10E	48DBA2-10E		
15E	48DBA2-15E		
20E	48DBA2-20E		
25E	48DBA2-25E		
30E	48DBA2-30E		
40E	48DBA2-40E		
50E	48DBA2-50E		
65E	48DBA2-65E		
80E	48DBA2-80E		
100E	48DBA2-100E		
125E	48DBA2-125E		
150E	48DBA2-150E		
200E	48DBA2-200E		
72 kV Max (69 kV Nominal)			
0.5E	72DBA2-5E	(10, 12)	16.0
3E	72DBA2-3E		
5E	72DBA2-5E		
7E	72DBA2-7E		
10E	72DBA2-10E		
15E	72DBA2-15E		
20E	72DBA2-20E		
25E	72DBA2-25E		
30E	72DBA2-30E		
40E	72DBA2-40E		
50E	72DBA2-50E		
65E	72DBA2-65E		
80E	72DBA2-80E		
100E	72DBA2-100E		
125E	72DBA2-125E		
150E	72DBA2-150E		
200E	72DBA2-200E		

Rating Amperes	DBA - 2 Fuse Units		Approximate Shipping Weight
	Catalog Number	Curve Reference 36-623	
Type DBA-2 Fuse Refills			
92 kV Max (92 kV Nominal)			
3E	92DBA2-3E	(10, 13)	16.0
5E	92DBA2-5E		
7E	92DBA2-7E		
10E	92DBA2-10E		
15E	92DBA2-15E		
20E	92DBA2-20E		
25E	92DBA2-25E		
30E	92DBA2-30E		
40E	92DBA2-40E		
50E	92DBA2-50E		
65E	92DBA2-65E		
80E	92DBA2-80E		
100E	92DBA2-100E		
125E	92DBA2-125E		
150E	92DBA2-150E		
200E	92DBA2-200E		
121 kV Max (115 kV Nominal)			
3E	121DBA2-3E	(10, 13)	15.0
5E	121DBA2-5E		
7E	121DBA2-7E		
10E	121DBA2-10E		
15E	121DBA2-15E		
20E	121DBA2-20E		
25E	121DBA2-25E		
30E	121DBA2-30E		
40E	121DBA2-40E		
50E	121DBA2-50E		
65E	121DBA2-65E		
80E	121DBA2-80E		
100E	121DBA2-100E		
125E	121DBA2-125E		
150E	121DBA2-150E		
200E	121DBA2-200E		
145 kV Max (138 kV Nominal)			
3E	145DBA2-3E	(10, 13)	14.0
5E	145DBA2-5E		
7E	145DBA2-7E		
10E	145DBA2-10E		
15E	145DBA2-15E		
20E	145DBA2-20E		
25E	145DBA2-25E		
30E	145DBA2-30E		
40E	145DBA2-40E		
50E	145DBA2-50E		
65E	145DBA2-65E		
80E	145DBA2-80E		
100E	145DBA2-100E		
125E	145DBA2-125E		
150E	145DBA2-150E		
200E	145DBA2-200E		

Cross Reference Guide

Catalog Number	Style Number	List Price	Catalog Number	Style Number	List Price	Catalog Number	Style Number	List Price
14RBA2-DL	9078A26A01	\$366.00	15RBA2-50E	423D814A31	\$262.00	15RBT4-200E	449D672A43	\$515.00
14RBA2-GDM	9078A25G04	\$510.00	15RBA2-65E	423D814A32	\$262.00	15RBT4-250E	449D672A44	\$515.00
14RBA2-PNM	9078A33G03	\$540.00	15RBA2-80E	423D814A33	\$262.00	15RBT4-300E	449D672A45	\$515.00
14RBA4-GDM	9078A19G04	\$720.00	15RBA2-DH	309C558G02	\$635.00	15RDB4-DH	310C131G02	\$1,000.00
14RBA4-GNM	9078A33G21	\$283.00	15RBA2-IDH	5981C50G02	\$710.00	15RDB4-VM	140D341G12	\$1,565.00
14RBA4-PDM	9078A19G03	\$1,000.00	15RBA2-INH	5981C51G02	\$580.00	25BA4-125E	116D977A54	\$665.00
14RBA4-PNM	9078A33G08	\$555.00	15RBA2-NH	677C370G02	\$510.00	25DBA1-100E	5980C16G14	\$850.00
14RBA8-GNM	9078A33G24	\$345.00	15RBA2-NL	9078A30A01	\$146.00	25DBA1-125E	5980C16G15	\$850.00
14RBA8-PNM	9078A33G13	\$555.00	15RBA2-SHNT	309C548G06	\$165.00	25DBA1-150E	5980C16G16	\$850.00
15BA2-100E	117D123A29	\$476.00	15RBA4-100E	423D815A39	\$338.00	25DBA1-200E	5980C16G17	\$850.00
15BA2-125E	117D123A30	\$514.00	15RBA4-125E	423D815A40	\$338.00	25RBA2-100E	423D814A54	\$336.00
15BA2-200E	117D123A32	\$514.00	15RBA4-150E	423D815A41	\$338.00	25RBA2-125E	423D814A55	\$336.00
15BA2-20E	117D123A22	\$476.00	15RBA4-15E	423D815A31	\$338.00	25RBA2-150E	423D814A56	\$336.00
15BA2-30E	117D123A24	\$476.00	15RBA4-200E	423D815A43	\$343.00	25RBA2-200E	423D814A58	\$336.00
15BA2-40E	117D123A25	\$476.00	15RBA4-20E	423D815A32	\$338.00	25RBA2-65E	423D814A52	\$336.00
15BA2-50E	117D123A26	\$476.00	15RBA4-250E	423D815A44	\$343.00	25RBA2-80E	423D814A53	\$336.00
15BA2-NH	310C198G02	\$1,172.00	15RBA4-300E	423D815A45	\$343.00	25RBA2-DH	309C558G03	\$685.00
15BA4-.5E	116D977A21	\$637.00	15RBA4-30E	423D815A34	\$338.00	25RBA2-INH	5981C51G03	\$650.00
15BA4-100E	116D977A33	\$637.00	15RBA4-400E	423D815A47	\$343.00	25RBA2-NH	677C370G03	\$635.00
15BA4-125E	116D977A34	\$642.00	15RBA4-40E	423D815A35	\$338.00	25RBA4-100E	423D815A64	\$373.00
15BA4-150E	116D977A35	\$642.00	15RBA4-50E	423D815A36	\$338.00	25RBA4-125E	423D815A65	\$373.00
15BA4-200E	116D977A36	\$642.00	15RBA4-5E	423D815A28	\$338.00	25RBA4-150E	423D815A66	\$373.00
15BA4-300E	116D977A38	\$642.00	15RBA4-65E	423D815A37	\$338.00	25RBA4-15E	423D815A56	\$373.00
15BA4-30E	116D977A28	\$637.00	15RBA4-7E	423D815A29	\$338.00	25RBA4-200E	423D815A68	\$373.00
15BA4-65E	116D977A31	\$637.00	15RBA4-80E	423D815A38	\$338.00	25RBA4-20E	423D815A57	\$373.00
15BA4-80E	116D977A32	\$637.00	15RBA4-DH	309C797G02	\$870.00	25RBA4-250E	423D815A69	\$373.00
15BA4-NH	310C196G02	\$2,119.00	15RBA4-DL	9078A20A01	\$575.00	25RBA4-300E	423D815A70	\$373.00
15DBA1-125E	5980C15G35	\$785.00	15RBA4-IDH	5981C52G02	\$1,020.00	25RBA4-30E	423D815A59	\$373.00
15DBA1-15E	5980C15G26	\$785.00	15RBA4-INH	5981C53G02	\$930.00	25RBA4-40E	423D815A60	\$373.00
15RBA2-100E	423D814A34	\$262.00	15RBA4-NH	677C371G02	\$870.00	25RBA4-50E	423D815A61	\$373.00
15RBA2-10E	423D814A25	\$262.00	15RBA4-NL	9078A30A03	\$146.00	25RBA4-65E	423D815A62	\$373.00
15RBA2-125E	423D814A35	\$276.00	15RBA4-PNM	9078A33G26	\$665.00	25RBA4-80E	423D815A63	\$373.00
15RBA2-150E	423D814A36	\$276.00	15RBA4-SHNT	678C283G02	\$174.00	25RBA4-DH	309C797G03	\$1,090.00
15RBA2-15E	423D814A26	\$262.00	15RBA8-INH	5981C54G02	\$1,765.00	25RBA4-INH	5981C53G03	\$1,145.00
15RBA2-200E	423D814A38	\$276.00	15RBA8-NH	5980C74G02	\$1,700.00	25RBA4-NH	677C371G03	\$1,085.00
15RBA2-20E	423D814A27	\$262.00	15RBA8-NL	9078A30A05	\$209.00	25RBA4-SHNT	678C283G03	\$174.00
15RBA2-25E	423D814A28	\$262.00	15RBA8-PNM	9078A33G27	\$585.00	25RBA8-NH	5980C74G03	\$1,795.00
15RBA2-30E	423D814A29	\$262.00	15RBT2-100E	449D671A34	\$426.00	25RDB2-DH	309C558G07	\$950.00
15RBA2-40E	423D814A30	\$262.00	15RBT2-65E	449D671A32	\$426.00	25RDB2-VM	140D340G13	\$1,565.00

Catalog Number	Style Number	List Price	Catalog Number	Style Number	List Price	Catalog Number	Style Number	List Price
25RDB4-DH	310C131G03	\$1,090.00	38RBA4-40E	423D815A85	\$399.00	72DBA1-50E	5980C17G31	\$1,125.00
38BA4-.5E	116D977A61	\$680.00	38RBA4-50E	423D815A86	\$399.00	72DBA1-5E	5980C17G23	\$1,125.00
38BA4-200E	116D977A76	\$715.00	38RBA4-5E	423D815A78	\$399.00	72DBA1-65E	5980C17G32	\$1,125.00
38BA4-40E	116D977A69	\$680.00	38RBA4-65E	423D815A87	\$399.00	72DBA2-.5E	22A6782G06	\$2,825.00
38DBA1-100E	5980C16G34	\$915.00	38RBA4-80E	423D815A88	\$399.00	72DBA2-15E	11A8127G05	\$2,825.00
38DBA1-10E	5980C16G25	\$915.00	38RBA4-DH	309C797G04	\$1,210.00	72DBA2-65E	11A8127G11	\$2,825.00
38DBA1-125E	5980C16G35	\$915.00	38RBA4-DL	9078A20A02	\$535.00	8BA2-100E	117D123A13	\$437.00
38DBA1-150E	5980C16G36	\$915.00	38RBA4-INH	5981C53G04	\$1,275.00	8BA2-125E	117D123A14	\$476.00
38DBA1-200E	5980C16G37	\$915.00	38RBA4-NH	677C371G04	\$1,210.00	8BA2-150E	117D123A15	\$476.00
38DBA1-3E	505D420G04	\$915.00	38RBA4-NL	9078A30A04	\$230.00	8BA2-15E	117D123A05	\$437.00
38DBA1-5E	5980C16G23	\$915.00	38RBA4-PDM	9078A19G07	\$1,450.00	8BA2-200E	117D123A16	\$476.00
38DBA1-7E	5980C16G24	\$915.00	38RBA4-PNM	9078A33G10	\$1,105.00	8BA2-25E	117D123A07	\$437.00
38DBA1-80E	5980C16G33	\$915.00	38RBA8-INH	5981C54G04	\$1,945.00	8BA2-30E	117D123A08	\$437.00
38DBA2-125E	18A7330G25	\$2,185.00	38RBA8-NH	5980C74G04	\$1,880.00	8BA2-50E	117D123A10	\$437.00
38DBA2-150E	18A7330G26	\$2,185.00	38RBA8-NL	9078A30A06	\$241.00	8BA2-5E	117D123A02	\$437.00
38DBA2-3E	505D420G07	\$2,185.00	38RBT4-100E	449D672A89	\$680.00	8BA2-65E	117D123A11	\$437.00
38DBA2-5E	18A7330G13	\$2,185.00	38RBT4-125E	449D672A90	\$680.00	8BA2-80E	117D123A12	\$437.00
38RBA2-100E	423D814A74	\$362.00	38RBT4-150E	449D672A91	\$301.24	8BA2-MDH	117D122G01	\$963.00
38RBA2-125E	423D814A75	\$362.00	38RDB4-DH	310C131G04	\$1,210.00	8BA4-200E	116D977A16	\$637.00
38RBA2-15E	423D814A66	\$362.00	38RDB4-SHNT	678C284G04	\$371.00	8BA4-250E	116D977A17	\$637.00
38RBA2-200E	423D814A78	\$362.00	38RDB4-VM	140D341G14	\$1,900.00	8BA4-300E	116D977A18	\$637.00
38RBA2-20E	423D814A67	\$362.00	48DBA1-.5E	5980C17G01	\$1,040.00	8BA4-400E	116D977A19	\$637.00
38RBA2-40E	423D814A70	\$362.00	48DBA1-100E	5980C17G14	\$1,040.00	8BA4-65E	116D977A11	\$599.00
38RBA2-50E	423D814A71	\$362.00	48DBA1-25E	5980C17G08	\$1,040.00	8BA4-80E	116D977A12	\$599.00
38RBA2-65E	423D814A72	\$362.00	48DBA1-40E	5980C17G10	\$1,040.00	8BA4-DH	676C880G01	\$1,573.00
38RBA2-80E	423D814A73	\$362.00	48DBA1-50E	5980C17G11	\$1,040.00	8BA8-NH	677C605G01	\$2,964.00
38RBA2-DH	309C558G04	\$685.00	48DBA1-65E	5980C17G12	\$1,040.00	8RBA2-100E	423D814A14	\$250.00
38RBA2-DL	9078A26A02	\$385.00	48DBA2-100E	18A7330G44	\$2,480.00	8RBA2-125E	423D814A15	\$262.00
38RBA2-INH	5981C51G04	\$735.00	48DBA2-150E	18A7330G46	\$2,480.00	8RBA2-150E	423D814A16	\$262.00
38RBA2-NH	677C370G04	\$675.00	48DBA2-200E	18A7330G47	\$2,480.00	8RBA2-200E	423D814A18	\$262.00
38RBA2-NL	9078A30A02	\$230.00	48DBA2-80E	18A7330G43	\$2,480.00	8RBA2-30E	423D814A09	\$250.00
38RBA2-PNM	9078A33G05	\$1,105.00	5RBA2-PNM	9078A33G01	\$463.00	8RBA2-40E	423D814A10	\$250.00
38RBA4-100E	423D815A89	\$399.00	5RBA4-GDM	9078A19G02	\$700.00	8RBA2-50E	423D814A11	\$250.00
38RBA4-125E	423D815A90	\$399.00	72DBA1-.5E	5980C17G21	\$1,125.00	8RBA2-65E	423D814A12	\$250.00
38RBA4-150E	423D815A91	\$399.00	72DBA1-100E	5980C17G34	\$1,125.00	8RBA2-80E	423D814A13	\$250.00
38RBA4-200E	423D815A93	\$399.00	72DBA1-15E	5980C17G26	\$1,125.00	8RBA2-DH	309C558G01	\$635.00
38RBA4-20E	423D815A82	\$399.00	72DBA1-20E	5980C17G27	\$1,125.00	8RBA2-GDM	9078A25G09	\$510.00
38RBA4-250E	423D815A94	\$399.00	72DBA1-30E	5980C17G29	\$1,125.00	8RBA2-GNM	9078A33G17	\$292.00
38RBA4-300E	423D815A95	\$399.00	72DBA1-40E	5980C17G30	\$1,125.00	8RBA2-INH	5981C51G01	\$550.00

Catalog Number	Style Number	List Price	Catalog Number	Style Number	List Price	Catalog Number	Style Number	List Price
8RBA2-NH	677C370G01	\$417.00	DBU17-7E	5981C76G02	\$90.00	DBU27-50K	5981C85G11	\$93.50
8RBA4-100E	423D815A14	\$336.00	DBU17-10E	5981C76G03	\$90.00	DBU27-65K	5981C85G12	\$93.50
8RBA4-125E	423D815A15	\$336.00	DBU17-13E	5981C76G04	\$90.00	DBU27-80K	5981C85G13	\$93.50
8RBA4-150E	423D815A16	\$336.00	DBU17-15E	5981C76G05	\$90.00	DBU27-100K	5981C85G14	\$93.50
8RBA4-200E	423D815A18	\$336.00	DBU17-20E	5981C76G06	\$90.00	DBU27-140K	5981C85G15	\$93.50
8RBA4-250E	423D815A19	\$336.00	DBU17-25E	5981C76G07	\$90.00	DBU27-200K	5981C85G16	\$93.50
8RBA4-300E	423D815A20	\$336.00	DBU17-30E	5981C76G08	\$90.00	DBU27-5E	5981C86G01	\$93.50
8RBA4-400E	423D815A22	\$336.00	DBU17-40E	5981C76G09	\$90.00	DBU27-7E	5981C86G02	\$93.50
8RBA4-40E	423D815A10	\$336.00	DBU17-50E	5981C76G10	\$90.00	DBU27-10E	5981C86G03	\$93.50
8RBA4-50E	423D815A11	\$336.00	DBU17-65E	5981C76G11	\$90.00	DBU27-13E	5981C86G04	\$93.50
8RBA4-80E	423D815A13	\$336.00	DBU17-80E	5981C76G12	\$90.00	DBU27-15E	5981C86G05	\$93.50
8RBA4-DH	309C797G01	\$835.00	DBU17-100E	5981C76G13	\$90.00	DBU27-20E	5981C86G06	\$93.50
8RBA4-GDM	9078A19G09	\$720.00	DBU17-125E	5981C76G14	\$90.00	DBU27-25E	5981C86G07	\$93.50
8RBA4-IDH	5981C52G01	\$900.00	DBU17-150E	5981C76G15	\$90.00	DBU27-30E	5981C86G08	\$93.50
8RBA4-INH	5981C53G01	\$715.00	DBU17-175E	5981C76G16	\$90.00	DBU27-40E	5981C86G09	\$93.50
8RBA4-NH	677C371G01	\$650.00	DBU17-200E	5981C76G17	\$90.00	DBU27-50E	5981C86G10	\$93.50
8RBA8-INH	5981C54G01	\$1,675.00	DBU17-15SE	5981C77G01	\$90.00	DBU27-65E	5981C86G11	\$93.50
8RBA8-NH	5980C74G01	\$1,615.00	DBU17-20SE	5981C77G02	\$90.00	DBU27-80E	5981C86G12	\$93.50
8RBT4-400E	449D672A21	\$500.00	DBU17-25SE	5981C77G03	\$90.00	DBU27-100E	5981C86G13	\$93.50
8RDB4-DH	310C131G01	\$995.00	DBU17-30SE	5981C77G04	\$90.00	DBU27-125E	5981C86G14	\$93.50
8RDB4-SHNT	678C284G01	\$371.00	DBU17-40SE	5981C77G05	\$90.00	DBU27-150E	5981C86G15	\$93.50
8RDB4-VM	140D341G11	\$1,545.00	DBU17-50SE	5981C77G06	\$90.00	DBU27-175E	5981C86G16	\$93.50
DBU17-3K	5981C75G01	\$90.00	DBU17-65SE	5981C77G07	\$90.00	DBU27-200E	5981C86G17	\$93.50
DBU17-6K	5981C75G02	\$90.00	DBU17-80SE	5981C77G08	\$90.00	DBU27-15SE	5981C87G01	\$93.50
DBU17-8K	5981C75G03	\$90.00	DBU17-100SE	5981C77G09	\$90.00	DBU27-20SE	5981C87G02	\$93.50
DBU17-10K	5981C75G04	\$90.00	DBU17-125SE	5981C77G10	\$90.00	DBU27-25SE	5981C87G03	\$93.50
DBU17-12K	5981C75G05	\$90.00	DBU17-150SE	5981C77G11	\$90.00	DBU27-30SE	5981C87G04	\$93.50
DBU17-15K	5981C75G06	\$90.00	DBU17-175SE	5981C77G12	\$90.00	DBU27-40SE	5981C87G05	\$93.50
DBU17-20K	5981C75G07	\$90.00	DBU17-200SE	5981C77G13	\$90.00	DBU27-50SE	5981C87G06	\$93.50
DBU17-25K	5981C75G08	\$90.00	DBU27-3K	5981C85G01	\$93.50	DBU27-65SE	5981C87G07	\$93.50
DBU17-30K	5981C75G09	\$90.00	DBU27-6K	5981C85G02	\$93.50	DBU27-80SE	5981C87G08	\$93.50
DBU17-40K	5981C75G10	\$90.00	DBU27-8K	5981C85G03	\$93.50	DBU27-100SE	5981C87G09	\$93.50
DBU17-50K	5981C75G11	\$90.00	DBU27-10K	5981C85G04	\$93.50	DBU27-125SE	5981C87G10	\$93.50
DBU17-65K	5981C75G12	\$90.00	DBU27-12K	5981C85G05	\$93.50	DBU27-150SE	5981C87G11	\$93.50
DBU17-80K	5981C75G13	\$90.00	DBU27-15K	5981C85G06	\$93.50	DBU27-175SE	5981C87G12	\$93.50
DBU17-100K	5981C75G14	\$90.00	DBU27-20K	5981C85G07	\$93.50	DBU27-200SE	5981C87G13	\$93.50
DBU17-140K	5981C75G15	\$90.00	DBU27-25K	5981C85G08	\$93.50	DBU38-3K	5981C95G01	\$102.50
DBU17-200K	5981C75G16	\$90.00	DBU27-30K	5981C85G09	\$93.50	DBU38-6K	5981C95G02	\$102.50
DBU17-5E	5981C76G01	\$90.00	DBU27-40K	5981C85G10	\$93.50	DBU38-8K	5981C95G03	\$102.50

Catalog Number	Style Number	List Price	Catalog Number	Style Number	List Price
DBU38-10K	5981C95G04	\$102.50	DBU38-125SE	5981C97G10	\$102.50
DBU38-12K	5981C95G05	\$102.50	DBU38-150SE	5981C97G11	\$102.50
DBU38-15K	5981C95G06	\$102.50	DBU38-175SE	5981C97G12	\$102.50
DBU38-20K	5981C95G07	\$102.50	DBU38-200SE	5981C97G13	\$102.50
DBU38-25K	5981C95G08	\$102.50	DBU-EFID	7187A11G01	\$182.35
DBU38-30K	5981C95G09	\$102.50	DBU-EFOD	7187A11G02	\$66.55
DBU38-40K	5981C95G10	\$102.50	DBU-MFLR	5981C69G01	\$126.70
DBU38-50K	5981C95G11	\$102.50	RBA2-COND	310C197G03	\$198.00
DBU38-65K	5981C95G12	\$102.50	RBA2-FLTR	309C024G03	\$194.00
DBU38-80K	5981C95G13	\$102.50	RBA4-COND	310C197G04	\$333.00
DBU38-100K	5981C95G14	\$102.50	RBA4-FLTR	591C607G01	\$286.00
DBU38-140K	5981C95G15	\$102.50	RBA4-FLTR-HC	591C607G02	\$481.00
DBU38-200K	5981C95G16	\$102.50	RBA4-IND	5980C29G02	\$163.00
DBU38-5E	5981C96G01	\$102.50			
DBU38-7E	5981C96G02	\$102.50			
DBU38-10E	5981C96G03	\$102.50			
DBU38-13E	5981C96G04	\$102.50			
DBU38-15E	5981C96G05	\$102.50			
DBU38-20E	5981C96G06	\$102.50			
DBU38-25E	5981C96G07	\$102.50			
DBU38-30E	5981C96G08	\$102.50			
DBU38-40E	5981C96G09	\$102.50			
DBU38-50E	5981C96G10	\$102.50			
DBU38-65E	5981C96G11	\$102.50			
DBU38-80E	5981C96G12	\$102.50			
DBU38-100E	5981C96G13	\$102.50			
DBU38-125E	5981C96G14	\$102.50			
DBU38-150E	5981C96G15	\$102.50			
DBU38-175E	5981C96G16	\$102.50			
DBU38-200E	5981C96G17	\$102.50			
DBU38-15SE	5981C97G01	\$102.50			
DBU38-20SE	5981C97G02	\$102.50			
DBU38-25SE	5981C97G03	\$102.50			
DBU38-30SE	5981C97G04	\$102.50			
DBU38-40SE	5981C97G05	\$102.50			
DBU38-50SE	5981C97G06	\$102.50			
DBU38-65SE	5981C97G07	\$102.50			
DBU38-80SE	5981C97G08	\$102.50			
DBU38-100SE	5981C97G09	\$102.50			

Style Number	Catalog Number	List Price	Style Number	Catalog Number	List Price	Style Number	Catalog Number	List Price
116D977A11	8BA4-65E	\$599.00	11A8127G11	72DBA2-65E	\$2,825.00	423D814A16	8RBA2-150E	\$262.00
116D977A12	8BA4-80E	\$599.00	140D340G13	25RDB2-VM	\$1,565.00	423D814A18	8RBA2-200E	\$262.00
116D977A16	8BA4-200E	\$637.00	140D341G11	8RDB4-VM	\$1,545.00	423D814A25	15RBA2-10E	\$262.00
116D977A17	8BA4-250E	\$637.00	140D341G12	15RDB4-VM	\$1,565.00	423D814A26	15RBA2-15E	\$262.00
116D977A18	8BA4-300E	\$637.00	140D341G14	38RDB4-VM	\$1,900.00	423D814A27	15RBA2-20E	\$262.00
116D977A19	8BA4-400E	\$637.00	18A7330G13	38DBA2-5E	\$2,185.00	423D814A28	15RBA2-25E	\$262.00
116D977A21	15BA4-.5E	\$637.00	18A7330G25	38DBA2-125E	\$2,185.00	423D814A29	15RBA2-30E	\$262.00
116D977A28	15BA4-30E	\$637.00	18A7330G26	38DBA2-150E	\$2,185.00	423D814A30	15RBA2-40E	\$262.00
116D977A31	15BA4-65E	\$637.00	18A7330G43	48DBA2-80E	\$2,480.00	423D814A31	15RBA2-50E	\$262.00
116D977A32	15BA4-80E	\$637.00	18A7330G44	48DBA2-100E	\$2,480.00	423D814A32	15RBA2-65E	\$262.00
116D977A33	15BA4-100E	\$637.00	18A7330G46	48DBA2-150E	\$2,480.00	423D814A33	15RBA2-80E	\$262.00
116D977A34	15BA4-125E	\$642.00	18A7330G47	48DBA2-200E	\$2,480.00	423D814A34	15RBA2-100E	\$262.00
116D977A35	15BA4-150E	\$642.00	22A6782G06	72DBA2-.5E	\$2,825.00	423D814A35	15RBA2-125E	\$276.00
116D977A36	15BA4-200E	\$642.00	309C024G03	RBA2-FLTR	\$194.00	423D814A36	15RBA2-150E	\$276.00
116D977A38	15BA4-300E	\$642.00	309C548G06	15RBA2-SHNT	\$165.00	423D814A38	15RBA2-200E	\$276.00
116D977A54	25BA4-125E	\$665.00	309C558G01	8RBA2-DH	\$635.00	423D814A52	25RBA2-65E	\$336.00
116D977A61	38BA4-.5E	\$680.00	309C558G02	15RBA2-DH	\$635.00	423D814A53	25RBA2-80E	\$336.00
116D977A69	38BA4-40E	\$680.00	309C558G03	25RBA2-DH	\$685.00	423D814A54	25RBA2-100E	\$336.00
116D977A76	38BA4-200E	\$715.00	309C558G04	38RBA2-DH	\$685.00	423D814A55	25RBA2-125E	\$336.00
117D122G01	8BA2-MDH	\$963.00	309C558G07	25RDB2-DH	\$950.00	423D814A56	25RBA2-150E	\$336.00
117D123A02	8BA2-5E	\$437.00	309C797G01	8RBA4-DH	\$835.00	423D814A58	25RBA2-200E	\$336.00
117D123A05	8BA2-15E	\$437.00	309C797G02	15RBA4-DH	\$870.00	423D814A66	38RBA2-15E	\$362.00
117D123A07	8BA2-25E	\$437.00	309C797G03	25RBA4-DH	\$1,090.00	423D814A67	38RBA2-20E	\$362.00
117D123A08	8BA2-30E	\$437.00	309C797G04	38RBA4-DH	\$1,210.00	423D814A70	38RBA2-40E	\$362.00
117D123A10	8BA2-50E	\$437.00	310C131G01	8RDB4-DH	\$995.00	423D814A71	38RBA2-50E	\$362.00
117D123A11	8BA2-65E	\$437.00	310C131G02	15RDB4-DH	\$1,000.00	423D814A72	38RBA2-65E	\$362.00
117D123A12	8BA2-80E	\$437.00	310C131G03	25RDB4-DH	\$1,090.00	423D814A73	38RBA2-80E	\$362.00
117D123A13	8BA2-100E	\$437.00	310C131G04	38RDB4-DH	\$1,210.00	423D814A74	38RBA2-100E	\$362.00
117D123A14	8BA2-125E	\$476.00	310C196G02	15BA4-NH	\$2,119.00	423D814A75	38RBA2-125E	\$362.00
117D123A15	8BA2-150E	\$476.00	310C197G03	RBA2-COND	\$198.00	423D814A78	38RBA2-200E	\$362.00
117D123A16	8BA2-200E	\$476.00	310C197G04	RBA4-COND	\$333.00	423D815A10	8RBA4-40E	\$336.00
117D123A22	15BA2-20E	\$476.00	310C198G02	15BA2-NH	\$1,172.00	423D815A11	8RBA4-50E	\$336.00
117D123A24	15BA2-30E	\$476.00	423D814A09	8RBA2-30E	\$250.00	423D815A13	8RBA4-80E	\$336.00
117D123A25	15BA2-40E	\$476.00	423D814A10	8RBA2-40E	\$250.00	423D815A14	8RBA4-100E	\$336.00
117D123A26	15BA2-50E	\$476.00	423D814A11	8RBA2-50E	\$250.00	423D815A15	8RBA4-125E	\$336.00
117D123A29	15BA2-100E	\$476.00	423D814A12	8RBA2-65E	\$250.00	423D815A16	8RBA4-150E	\$336.00
117D123A30	15BA2-125E	\$514.00	423D814A13	8RBA2-80E	\$250.00	423D815A18	8RBA4-200E	\$336.00
117D123A32	15BA2-200E	\$514.00	423D814A14	8RBA2-100E	\$250.00	423D815A19	8RBA4-250E	\$336.00
11A8127G05	72DBA2-15E	\$2,825.00	423D814A15	8RBA2-125E	\$262.00	423D815A20	8RBA4-300E	\$336.00

Style Number	Catalog Number	List Price	Style Number	Catalog Number	List Price	Style Number	Catalog Number	List Price
423D815A22	8RBA4-400E	\$336.00	423D815A93	38RBA4-200E	\$399.00	5980C17G27	72DBA1-20E	\$1,125.00
423D815A28	15RBA4-5E	\$338.00	423D815A94	38RBA4-250E	\$399.00	5980C17G29	72DBA1-30E	\$1,125.00
423D815A29	15RBA4-7E	\$338.00	423D815A95	38RBA4-300E	\$399.00	5980C17G30	72DBA1-40E	\$1,125.00
423D815A31	15RBA4-15E	\$338.00	449D671A32	15RBT2-65E	\$426.00	5980C17G31	72DBA1-50E	\$1,125.00
423D815A32	15RBA4-20E	\$338.00	449D671A34	15RBT2-100E	\$426.00	5980C17G32	72DBA1-65E	\$1,125.00
423D815A34	15RBA4-30E	\$338.00	449D672A21	8RBT4-400E	\$500.00	5980C17G34	72DBA1-100E	\$1,125.00
423D815A35	15RBA4-40E	\$338.00	449D672A43	15RBT4-200E	\$515.00	5980C29G02	RBA4-IND	\$163.00
423D815A36	15RBA4-50E	\$338.00	449D672A44	15RBT4-250E	\$515.00	5980C74G01	8RBA8-NH	\$1,615.00
423D815A37	15RBA4-65E	\$338.00	449D672A45	15RBT4-300E	\$515.00	5980C74G02	15RBA8-NH	\$1,700.00
423D815A38	15RBA4-80E	\$338.00	449D672A89	38RBT4-100E	\$680.00	5980C74G03	25RBA8-NH	\$1,795.00
423D815A39	15RBA4-100E	\$338.00	449D672A90	38RBT4-125E	\$680.00	5980C74G04	38RBA8-NH	\$1,880.00
423D815A40	15RBA4-125E	\$338.00	449D672A91	38RBT4-150E	\$301.24	5981C50G02	15RBA2-IDH	\$710.00
423D815A41	15RBA4-150E	\$338.00	505D420G04	38DBA1-3E	\$915.00	5981C51G01	8RBA2-INH	\$550.00
423D815A43	15RBA4-200E	\$343.00	505D420G07	38DBA2-3E	\$2,185.00	5981C51G02	15RBA2-INH	\$580.00
423D815A44	15RBA4-250E	\$343.00	591C607G01	RBA4-FLTR	\$286.00	5981C51G03	25RBA2-INH	\$650.00
423D815A45	15RBA4-300E	\$343.00	591C607G02	RBA4-FLTR-HC	\$481.00	5981C51G04	38RBA2-INH	\$735.00
423D815A47	15RBA4-400E	\$343.00	5980C15G26	15DBA1-15E	\$785.00	5981C52G01	8RBA4-IDH	\$900.00
423D815A56	25RBA4-15E	\$373.00	5980C15G35	15DBA1-125E	\$785.00	5981C52G02	15RBA4-IDH	\$1,020.00
423D815A57	25RBA4-20E	\$373.00	5980C16G14	25DBA1-100E	\$850.00	5981C53G01	8RBA4-INH	\$715.00
423D815A59	25RBA4-30E	\$373.00	5980C16G15	25DBA1-125E	\$850.00	5981C53G02	15RBA4-INH	\$930.00
423D815A60	25RBA4-40E	\$373.00	5980C16G16	25DBA1-150E	\$850.00	5981C53G03	25RBA4-INH	\$1,145.00
423D815A61	25RBA4-50E	\$373.00	5980C16G17	25DBA1-200E	\$850.00	5981C53G04	38RBA4-INH	\$1,275.00
423D815A62	25RBA4-65E	\$373.00	5980C16G23	38DBA1-5E	\$915.00	5981C54G01	8RBA8-INH	\$1,675.00
423D815A63	25RBA4-80E	\$373.00	5980C16G24	38DBA1-7E	\$915.00	5981C54G02	15RBA8-INH	\$1,765.00
423D815A64	25RBA4-100E	\$373.00	5980C16G25	38DBA1-10E	\$915.00	5981C54G04	38RBA8-INH	\$1,945.00
423D815A65	25RBA4-125E	\$373.00	5980C16G33	38DBA1-80E	\$915.00	5981C69G01	DBU-MFLR	\$126.70
423D815A66	25RBA4-150E	\$373.00	5980C16G34	38DBA1-100E	\$915.00	5981C75G01	DBU17-3K	\$90.00
423D815A68	25RBA4-200E	\$373.00	5980C16G35	38DBA1-125E	\$915.00	5981C75G02	DBU17-6K	\$90.00
423D815A69	25RBA4-250E	\$373.00	5980C16G36	38DBA1-150E	\$915.00	5981C75G03	DBU17-8K	\$90.00
423D815A70	25RBA4-300E	\$373.00	5980C16G37	38DBA1-200E	\$915.00	5981C75G04	DBU17-10K	\$90.00
423D815A78	38RBA4-5E	\$399.00	5980C17G01	48DBA1-.5E	\$1,040.00	5981C75G05	DBU17-12K	\$90.00
423D815A82	38RBA4-20E	\$399.00	5980C17G08	48DBA1-25E	\$1,040.00	5981C75G06	DBU17-15K	\$90.00
423D815A85	38RBA4-40E	\$399.00	5980C17G10	48DBA1-40E	\$1,040.00	5981C75G07	DBU17-20K	\$90.00
423D815A86	38RBA4-50E	\$399.00	5980C17G11	48DBA1-50E	\$1,040.00	5981C75G08	DBU17-25K	\$90.00
423D815A87	38RBA4-65E	\$399.00	5980C17G12	48DBA1-65E	\$1,040.00	5981C75G09	DBU17-30K	\$90.00
423D815A88	38RBA4-80E	\$399.00	5980C17G14	48DBA1-100E	\$1,040.00	5981C75G10	DBU17-40K	\$90.00
423D815A89	38RBA4-100E	\$399.00	5980C17G21	72DBA1-.5E	\$1,125.00	5981C75G11	DBU17-50K	\$90.00
423D815A90	38RBA4-125E	\$399.00	5980C17G23	72DBA1-5E	\$1,125.00	5981C75G12	DBU17-65K	\$90.00
423D815A91	38RBA4-150E	\$399.00	5980C17G26	72DBA1-15E	\$1,125.00	5981C75G13	DBU17-80K	\$90.00

Style Number	Catalog Number	List Price	Style Number	Catalog Number	List Price	Style Number	Catalog Number	List Price
5981C75G14	DBU17-100K	\$90.00	5981C85G07	DBU27-20K	\$93.50	5981C87G13	DBU27-200SE	\$93.50
5981C75G15	DBU17-140K	\$90.00	5981C85G08	DBU27-25K	\$93.50	5981C95G01	DBU38-3K	\$102.50
5981C75G16	DBU17-200K	\$90.00	5981C85G09	DBU27-30K	\$93.50	5981C95G02	DBU38-6K	\$102.50
5981C76G01	DBU17-5E	\$90.00	5981C85G10	DBU27-40K	\$93.50	5981C95G03	DBU38-8K	\$102.50
5981C76G02	DBU17-7E	\$90.00	5981C85G11	DBU27-50K	\$93.50	5981C95G04	DBU38-10K	\$102.50
5981C76G03	DBU17-10E	\$90.00	5981C85G12	DBU27-65K	\$93.50	5981C95G05	DBU38-12K	\$102.50
5981C76G04	DBU17-13E	\$90.00	5981C85G13	DBU27-80K	\$93.50	5981C95G06	DBU38-15K	\$102.50
5981C76G05	DBU17-15E	\$90.00	5981C85G14	DBU27-100K	\$93.50	5981C95G07	DBU38-20K	\$102.50
5981C76G06	DBU17-20E	\$90.00	5981C85G15	DBU27-140K	\$93.50	5981C95G08	DBU38-25K	\$102.50
5981C76G07	DBU17-25E	\$90.00	5981C85G16	DBU27-200K	\$93.50	5981C95G09	DBU38-30K	\$102.50
5981C76G08	DBU17-30E	\$90.00	5981C86G01	DBU27-5E	\$93.50	5981C95G10	DBU38-40K	\$102.50
5981C76G09	DBU17-40E	\$90.00	5981C86G02	DBU27-7E	\$93.50	5981C95G11	DBU38-50K	\$102.50
5981C76G10	DBU17-50E	\$90.00	5981C86G03	DBU27-10E	\$93.50	5981C95G12	DBU38-65K	\$102.50
5981C76G11	DBU17-65E	\$90.00	5981C86G04	DBU27-13E	\$93.50	5981C95G13	DBU38-80K	\$102.50
5981C76G12	DBU17-80E	\$90.00	5981C86G05	DBU27-15E	\$93.50	5981C95G14	DBU38-100K	\$102.50
5981C76G13	DBU17-100E	\$90.00	5981C86G06	DBU27-20E	\$93.50	5981C95G15	DBU38-140K	\$102.50
5981C76G14	DBU17-125E	\$90.00	5981C86G07	DBU27-25E	\$93.50	5981C95G16	DBU38-200K	\$102.50
5981C76G15	DBU17-150E	\$90.00	5981C86G08	DBU27-30E	\$93.50	5981C96G01	DBU38-5E	\$102.50
5981C76G16	DBU17-175E	\$90.00	5981C86G09	DBU27-40E	\$93.50	5981C96G02	DBU38-7E	\$102.50
5981C76G17	DBU17-200E	\$90.00	5981C86G10	DBU27-50E	\$93.50	5981C96G03	DBU38-10E	\$102.50
5981C77G01	DBU17-15SE	\$90.00	5981C86G11	DBU27-65E	\$93.50	5981C96G04	DBU38-13E	\$102.50
5981C77G02	DBU17-20SE	\$90.00	5981C86G12	DBU27-80E	\$93.50	5981C96G05	DBU38-15E	\$102.50
5981C77G03	DBU17-25SE	\$90.00	5981C86G13	DBU27-100E	\$93.50	5981C96G06	DBU38-20E	\$102.50
5981C77G04	DBU17-30SE	\$90.00	5981C86G14	DBU27-125E	\$93.50	5981C96G07	DBU38-25E	\$102.50
5981C77G05	DBU17-40SE	\$90.00	5981C86G15	DBU27-150E	\$93.50	5981C96G08	DBU38-30E	\$102.50
5981C77G06	DBU17-50SE	\$90.00	5981C86G16	DBU27-175E	\$93.50	5981C96G09	DBU38-40E	\$102.50
5981C77G07	DBU17-65SE	\$90.00	5981C86G17	DBU27-200E	\$93.50	5981C96G10	DBU38-50E	\$102.50
5981C77G08	DBU17-80SE	\$90.00	5981C87G01	DBU27-15SE	\$93.50	5981C96G11	DBU38-65E	\$102.50
5981C77G09	DBU17-100SE	\$90.00	5981C87G02	DBU27-20SE	\$93.50	5981C96G12	DBU38-80E	\$102.50
5981C77G10	DBU17-125SE	\$90.00	5981C87G03	DBU27-25SE	\$93.50	5981C96G13	DBU38-100E	\$102.50
5981C77G11	DBU17-150SE	\$90.00	5981C87G04	DBU27-30SE	\$93.50	5981C96G14	DBU38-125E	\$102.50
5981C77G12	DBU17-175SE	\$90.00	5981C87G05	DBU27-40SE	\$93.50	5981C96G15	DBU38-150E	\$102.50
5981C77G13	DBU17-200SE	\$90.00	5981C87G06	DBU27-50SE	\$93.50	5981C96G16	DBU38-175E	\$102.50
5981C85G01	DBU27-3K	\$93.50	5981C87G07	DBU27-65SE	\$93.50	5981C96G17	DBU38-200E	\$102.50
5981C85G02	DBU27-6K	\$93.50	5981C87G08	DBU27-80SE	\$93.50	5981C97G01	DBU38-15SE	\$102.50
5981C85G03	DBU27-8K	\$93.50	5981C87G09	DBU27-100SE	\$93.50	5981C97G02	DBU38-20SE	\$102.50
5981C85G04	DBU27-10K	\$93.50	5981C87G10	DBU27-125SE	\$93.50	5981C97G03	DBU38-25SE	\$102.50
5981C85G05	DBU27-12K	\$93.50	5981C87G11	DBU27-150SE	\$93.50	5981C97G04	DBU38-30SE	\$102.50
5981C85G06	DBU27-15K	\$93.50	5981C87G12	DBU27-175SE	\$93.50	5981C97G05	DBU38-40SE	\$102.50

Style Number	Catalog Number	List Price	Style Number	Catalog Number	List Price
5981C97G06	DBU38-50SE	\$102.50	9078A30A05	15RBA8-NL	\$209.00
5981C97G07	DBU38-65SE	\$102.50	9078A30A06	38RBA8-NL	\$241.00
5981C97G08	DBU38-80SE	\$102.50	9078A33G01	5RBA2-PNM	\$463.00
5981C97G09	DBU38-100SE	\$102.50	9078A33G03	14RBA2-PNM	\$540.00
5981C97G10	DBU38-125SE	\$102.50	9078A33G05	38RBA2-PNM	\$1,105.00
5981C97G11	DBU38-150SE	\$102.50	9078A33G08	14RBA4-PNM	\$555.00
5981C97G12	DBU38-175SE	\$102.50	9078A33G10	38RBA4-PNM	\$1,105.00
5981C97G13	DBU38-200SE	\$102.50	9078A33G13	14RBA8-PNM	\$555.00
676C880G01	8BA4-DH	\$1,573.00	9078A33G17	8RBA2-GNM	\$292.00
677C370G01	8RBA2-NH	\$417.00	9078A33G21	14RBA4-GNM	\$283.00
677C370G02	15RBA2-NH	\$510.00	9078A33G24	14RBA8-GNM	\$345.00
677C370G03	25RBA2-NH	\$635.00	9078A33G26	15RBA4-PNM	\$665.00
677C370G04	38RBA2-NH	\$675.00	9078A33G27	15RBA8-PNM	\$585.00
677C371G01	8RBA4-NH	\$650.00			
677C371G02	15RBA4-NH	\$870.00			
677C371G03	25RBA4-NH	\$1,085.00			
677C371G04	38RBA4-NH	\$1,210.00			
677C605G01	8BA8-NH	\$2,964.00			
678C283G02	15RBA4-SHNT	\$174.00			
678C283G03	25RBA4-SHNT	\$174.00			
678C284G01	8RDB4-SHNT	\$371.00			
678C284G04	38RDB4-SHNT	\$371.00			
7187A11G01	DBU-EFID	\$182.35			
7187A11G02	DBU-EFOD	\$66.55			
9078A19G02	5RBA4-GDM	\$700.00			
9078A19G03	14RBA4-PDM	\$1,000.00			
9078A19G04	14RBA4-GDM	\$720.00			
9078A19G07	38RBA4-PDM	\$1,450.00			
9078A19G09	8RBA4-GDM	\$720.00			
9078A20A01	15RBA4-DL	\$575.00			
9078A20A02	38RBA4-DL	\$535.00			
9078A25G04	14RBA2-GDM	\$510.00			
9078A25G09	8RBA2-GDM	\$510.00			
9078A26A01	14RBA2-DL	\$366.00			
9078A26A02	38RBA2-DL	\$385.00			
9078A30A01	15RBA2-NL	\$146.00			
9078A30A02	38RBA2-NL	\$230.00			
9078A30A03	15RBA4-NL	\$146.00			
9078A30A04	38RBA4-NL	\$230.00			

Company Information

Eaton's Cutler-Hammer business is a worldwide leader providing customer-driven solutions. From power distribution and electrical control products to industrial automation, the Cutler-Hammer business utilizes advanced product development, world-class manufacturing, and offers global engineering services and support. To learn more about Eaton's innovative Cutler-Hammer products and solutions call 1-800-525-2000, for engineering services call 1-800-498-2678, or visit www.cutler-hammer.eaton.com.

Eaton is a global \$7.3 billion diversified industrial manufacturer that is a leader in fluid power systems; electrical power quality, distribution and control; automotive engine air management and fuel economy; and intelligent truck systems for fuel economy and safety. Eaton has 49,000 employees and sells products in more than 50 countries. For more information, visit www.eaton.com.

Eaton Corporation
Cutler-Hammer business unit
1000 Cherrington Parkway
Moon Township, PA 15108
United States
tel: 1-800-525-2000
www.cutler-hammer.eaton.com