

# 600 A 15/25 kV class separable splices



## General

Eaton's Cooper Power™ series 600 A, 15/25 kV Class deadbreak separable splices are used to splice two, three, or four cables or to deadend a single cable. They are fully shielded, submersible and meet the requirements of IEEE Std 386™-2006 standard – Separable Insulated Connector Systems. The splices are rated for 600 A or 900 A and are suitable for the repair or extension of underground feeders. Installed either direct buried or in a vault, 600 A separable splices can be used on all 15 and 25 kV Class power distribution systems. They are made of high quality peroxide cured EPDM rubber to provide excellent electrical, thermal and mechanical reliability. All have 5/8 inch-11 UNC 2A aluminum threads that meet IEEE Std 386™-2006 standard requirements for 600 A separable connections. Optional all copper components are also available.

The capacitive test point on the insulating plug provides a means of testing the circuit without disturbing the bolted connection.

In addition to the capacitive test point feature on the insulating plug, Eaton offers an optional Cooper Power series capacitive test point similar to the test points on its Cooper Power series 200 A elbow connectors. This allows the use of the test point faulted circuit indicators and provides a clampstick operable means of determining the circuit condition when used with a high impedance voltage sensing device designed for test points.

Separable splices and deadends are designed for use on solid dielectric cable (XLPE or EPR) with extruded semiconductive shields and concentric neutral, with or without a jacket. Installation on jacketed concentric neutral cable may require additional sealing material. Cold shrinkable adapters are available for tape shield, linear corrugated and drain wire cable adaptation for use with separable splices.

## 900 AMP rating

Separable splices are rated for 900 A continuous when used with a coppertop compression connector (ordered separately), copper insulating plug, copper connecting plug, and copper stud.

## Installation

The T-body splice housings are assembled onto prepared cable with spade lug compression connectors. The rubber connecting plugs used to connect the housings are tightened using a torque wrench, 1" socket, and a 5/16" hex drive. Refer to *Service Information MN650005EN 600 A 15/25 kV Class BOL-T and Separable Splice Connector Assembly Installation Instructions* for details.

**EATON**

*Powering Business Worldwide*

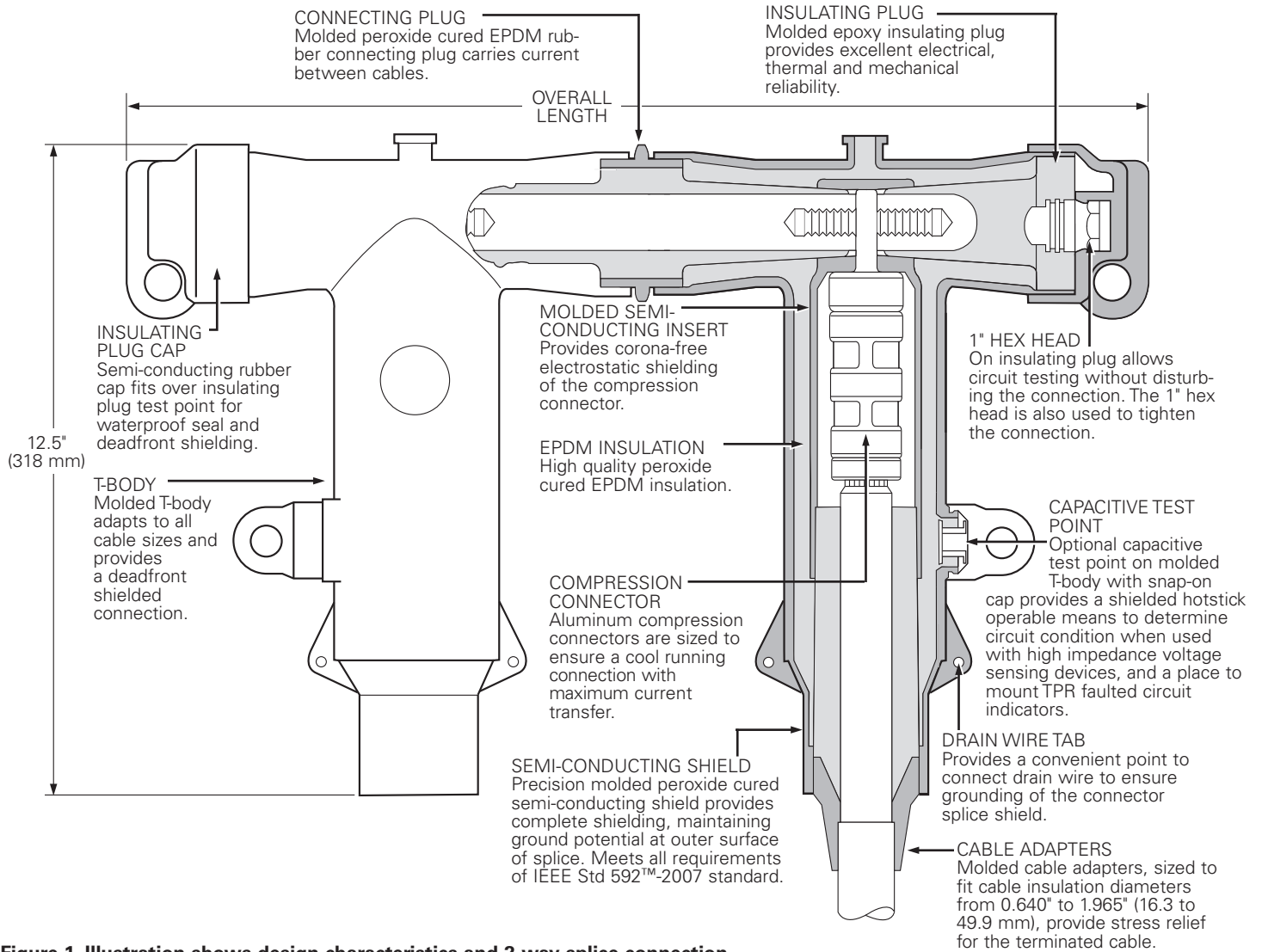

Figure 1. Illustration shows design characteristics and 2-way splice connection.

Note: Dimensions given are for reference only.

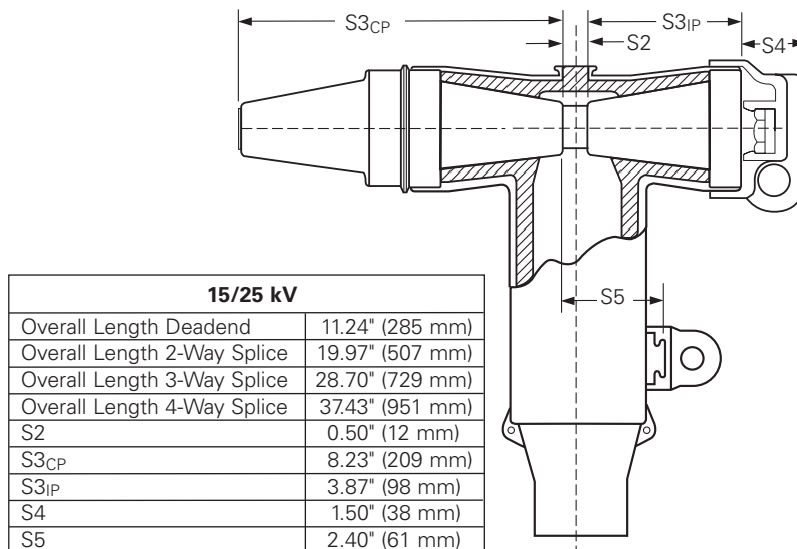

Figure 2. Separable splice stacking dimensions.

## Interchangeability

All Eaton's Cooper Power series 600 A deadbreak connectors conform to the electrical, mechanical and dimensional requirements of IEEE Std 386™-2006 standard. The connectors can be used on any comparably rated bushing interface that also meets the requirements of this standard. In addition, all cable adapters, insulating plugs, compression connectors and other component parts are designed to be interchangeable with those currently available from other major manufacturers.

## Production tests

Tests conducted in accordance with IEEE Std 386™-2006 standard:

- ac 60 Hz 1 Minute Withstand
  - 40 kV
- Minimum Partial Discharge Extinction Voltage
  - 19 kV
- Test Point Voltage Test

Tests conducted in accordance with Eaton requirements:

- Physical Inspection
- Periodic Dissection
- Periodic Fluoroscopic Analysis

**Table 1. Voltage Ratings and Characteristics**

Description	kV
Standard Voltage Class	25
Maximum Rating Phase-to-Ground	15.2
ac 60 Hz 1 Minute Withstand	40
dc 15 Minute Withstand	78
BIL and Full Wave Crest	125
Minimum Partial Discharge Extinction Voltage	19

Voltage ratings and characteristics are in accordance with IEEE Std 386™-2006 standard.

**Table 2. Current Ratings and Characteristics**

Description	Amperes
Continuous	600 A rms (Aluminum) 900 A rms (Copper)
4 Hour Overload	900 A rms (Aluminum) 1200 A rms (Copper)
Short Time (Aluminum)	40,000 A rms symmetrical for 0.17 s 27,000 A rms symmetrical for 4.0 s
Short Time (Copper or Shear Bolt)	40,000 A rms symmetrical for 0.17 s 27,000 A rms symmetrical for 4.0 s

Current ratings and characteristics are in accordance with IEEE Std 386™-2006 standard.

### Ordering information

To order a 600 A, 15/25 kV Deadend or Separable Splice kit, specify separate catalog numbers for:

- Basic Kit
- Each Compression Connector
- Each Cable Adapter
- One 5/16" Hex Drive HD625 (Figure 4)

Components included in separable splice kits and components that must be ordered separately are indicated in Tables 5 and 6.

Each kit contains:

- Silicone Lubricant
- Installation Instruction Sheet

#### Example:

For a 3-way cable splice without capacitive test points, with aluminum components for three different size cables, specify SSPL625A3 for the basic kit, three additional catalog numbers for the three compression connectors, three catalog numbers for the three cable adapters, and the number for the 5/16" Hex Drive, or a total of eight catalog numbers.

**Note:** If 900 A rating is required select copper components.

**Table 3. Separable Splice Kits**

Description	Catalog Number	Description	Catalog Number
<b>Deadend Kit</b>		<b>3-Way Splice Kit</b>	
Aluminum Components without Test Point	SSPL625A1	Aluminum Components without Test Point	SSPL625A3
Copper Components without Test Point	SSPL625C1	Copper Components without Test Point	SSPL625C3
Aluminum Components with Test Point	SSPL625A1T	Aluminum Components with Test Point	SSPL625A3T
Copper Components with Test Point	SSPL625C1T	Copper Components with Test Point	SSPL625C3T
<b>2-Way Splice Kit</b>		<b>4-Way Splice Kit</b>	
Aluminum Components without Test Point	SSPL625A2	Aluminum Components without Test Point	SSPL625A4
Copper Components without Test Point	SSPL625C2	Copper Components without Test Point	SSPL625C4
Aluminum Components with Test Point	SSPL625A2T	Aluminum Components with Test Point	SSPL625A4T
Copper Components with Test Point	SSPL625C2T	Copper Components with Test Point	SSPL625C4T

**Note:** Studs are bagged and loose in kit. To have studs permanently installed at the factory, add a "P" at the end of the part number.

**TABLE 4. Separable Splice Kits**

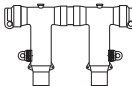
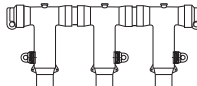
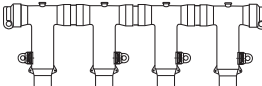
Assembly	Each Splice Kit Contains:				Order Separately:	
	T-Body	Insulating Plug with Cap	Insulating Plug with Cap and Stud	Connecting Plug	Cable Adapter (Table 5)	Compression Connector (Table 6)
 <b>Deadend</b>	1	1	1	–	1	1
 <b>2-Way Splice</b>	2	1	1	1	2	2
 <b>3-Way Splice</b>	3	1	1	2	3	3
 <b>4-Way Splice</b>	4	1	1	3	4	4

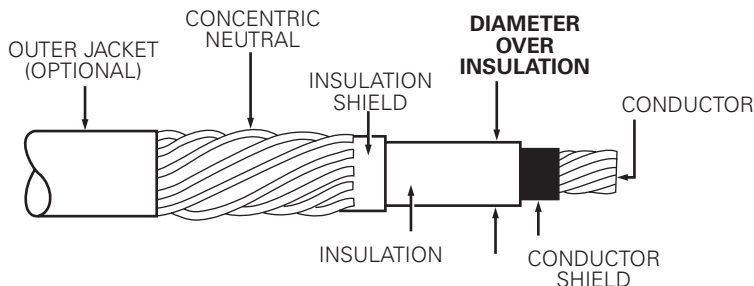

Figure 3. Cable cutaway showing conductor and insulation layers.

## Ordering information

### Cable adapter

To order cable adapters, refer to Table 5. These cable adapters are for use on Eaton's Cooper Power series BOLT™, T-OP™ II, BT-TAP™, and PUSH-OP™ connection systems as well as separable splices.

Determine the cable diameter over the high-voltage insulation as shown in Figure 3 and specify the catalog number using Table 5. Minimum and maximum cable insulation diameter must fall within the range of the appropriate cable adapter as AEIC cable diameter can vary  $\pm 0.030$ ".

Example: To order a cable adapter of 1.200 inches, determine the cable diameter range as follows:

$$1.200 - 0.030 = 1.170 \text{ minimum diameter}$$

$$1.200 + 0.030 = 1.230 \text{ maximum diameter}$$

Therefore, specify **CA625EE**.

Table 5. Cable Adapter

Cable Insulation Diameter Range

Inches	mm	Code
0.610-0.970	15.5-24.6	AB
0.750-1.080	19.1-27.4	CC
0.970-1.310	24.6-33.3	DD
1.090-1.470	27.7-37.3	EE
1.260-1.640	32.0-41.7	FF
1.360-1.710	34.5-43.4	GG
1.510-1.850	38.4-47.0	HH
1.700-1.970	43.2-50.0	JJ



Figure 4. HD625 Hex Drive.

## Ordering information

### Compression connectors

**Table 6. Replacement Parts**

Conductor Size				Catalog Number	
Concentric or Compressed		Compact or Solid		11/16 in. Unthreaded Aluminum	11/16 in. Unthreaded Coppertop
mm <sup>2</sup>	AWG or kcmil	mm <sup>2</sup>	AWG or kcmil		
–	3	–	2	CC6A10U	CC6C10U
–	2	–	1	CC6A11U	CC6C11U
–	1	–	1/0	CC6A12U	CC6C12U
50	1/0	70	2/0	CC6A13U	CC6C13U
70	2/0	–	3/0	CC6A14U	CC6C14U
–	3/0	95	4/0	CC6A15U	CC6C15U
95	4/0	120	250	CC6A16U	CC6C16U
120	250	–	300	CC6A17U	CC6C17U
–	300	–	350	CC6A18U	CC6C18U
–	350	185	400	CC6A19U	CC6C19U
185	400	–	450	CC6A20U	CC6C20U
–	450	240	500 <sup>a</sup>	CC6A21U	CC6C21U
240	500	300	600	CC6A22U	CC6C22U
300	600	–	700	CC6A23U	CC6C23U
–	650 <sup>b</sup>	–	750 <sup>c</sup>	CC6A24U	CC6C24U
–	750 <sup>d</sup>	–	900	CC6A25U	CC6C25U
–	900	500	1000	CC6A26U	CC6C26U
500	1000	–	–	CC6A27U	CC6C27U
1250	630	–	–	CC6A28U	CC6C28U

- a. Also accepts 550 kcmil compact conductor.
- b. Also accepts 700 kcmil compressed conductor.
- c. Also accepts 800 kcmil compact conductor.
- d. Also accepts 700 kcmil concentric conductor.

**Table 7. Shear Bolt Connector**

Cable Conductor Size				Conductor Code	Catalog Number
AWG or kcmil		mm <sup>2</sup>			
Compact	Compressed	Concentric	Standard Sizes		
1/0	1/0	1/0	50		
2/0	2/0	2/0	70		
3/0	3/0	3/0	95	<b>S1</b>	CDT630SB150
4/0	4/0	4/0	–		
250	250	250	120		
350	–	–	150		
–	350	350	185		
500	500	500	240	<b>S3</b>	CDT630SB300
600	600	600	300		
700	–	–	–		
–	700	700	–		
750	750	750	–	<b>S4</b>	CDT630SB400
800	800	–	400		
900	–	–	–		
–	–	800	–		
–	900	900	–	<b>S5</b>	CDT900SB500
1000	1000	1000	500		

**Table 8. Replacement Parts**

<b>Description</b>	<b>Catalog Number</b>
T-body without Test Point	DT625
T-body with Test Point	DT625T
Insulated Plug Cap	DIPCAP
Aluminum Insulating Plug with Cap, No Stud	DIP625A
Copper Insulating Plug with Cap, No Stud	DIP625C
Aluminum Insulating Plug with Cap and Aluminum Stud*	DIP625AS
Copper Insulating Plug with Cap and Copper Stud*	DIP625CS
Aluminum Connecting Plug, No Stud	DCP625A
Copper Connecting Plug, No Stud	DCP625C
Aluminum Connecting Plug, With Aluminum Stud*	DCP625AS
Copper Connecting Plug, With Copper Stud*	DCP625CS
5/8 in. - 11 UNC 2A Aluminum Threaded Stud	STUD-A
5/8 in. - 11 UNC 2A Copper Threaded Stud	STUD-C
5/16 in. Hex Shaft with 3/8 in. Socket Drive Tool	HD625

## Accessories

See Catalog CA650007EN for further information on Replacement Parts and Accessories.

**Eaton**  
1000 Eaton Boulevard  
Cleveland, OH 44122  
United States  
Eaton.com

**Eaton's Power Systems Division**  
2300 Badger Drive  
Waukesha, WI 53188  
United States  
Eaton.com/cooperpowerseries

© 2020 Eaton  
All Rights Reserved  
Printed in USA  
Publication No. CA650051EN  
November 2020

Eaton is a registered trademark.

All other trademarks are property  
of their respective owners.

For Eaton's Cooper Power series splice product  
information call 1-877-277-4636 or visit:  
[www.eaton.com/cooperpowerseries](http://www.eaton.com/cooperpowerseries).